

# ELECTRIC ACTUATORS E 50 - E 210



E 50

## TECHNICAL DATA

Types:	E 50 - E 210
Duty class:	Class C acc. to prEN WI69000095
Valve interface:	EN ISO 5211
Actuation time:	6 s - 180 s
Corrosion protection:	C4 acc. to prEN WI 6900095 tested acc. to EN 600068-2-52
Protection class:	IP 67 acc. to EN IEC 60529
Insulation class:	F
Limit switches:	max. 250 V AC, 3A for DS-Actuators max. 250 V AC, 3A for WS-Actuators max. 24 V DC, 10 A for GS-Actuators
Operation temperature:	-20°C to +70°C
Cable glands:	2 x M20 x 1,5; Ø min = 6 mm, Ø max = 13 mm
Hand wheel:	15 revolutions for for 90°
Hand wheel torque:	8 Nm for E 50 4 Nm for E 65 20 Nm for E 110 35 Nm for E 160 50 Nm for E 210

## FEATURES

- Robust aluminum body
- Completely ball beared wormgear
- Safe arresting by self-inhibition
- Changeable clutch nuts for mounting on different shaft ends
- Mechanical position indicator disc for an optical control of the valve's position
- Motor with thermic winding protection switch
- Hand wheel enables immediate hand emergency operation if necessary
- Maintenance-free, long life service by continuous lubrication

## GENERAL APPLICATIONS:

- Water and waste water technology
- Chemical industry
- Car industry
- Civil engineering
- Everywhere applicable, where butterfly valves are installed



E 160

# DIMENSIONS E 50 - E 210

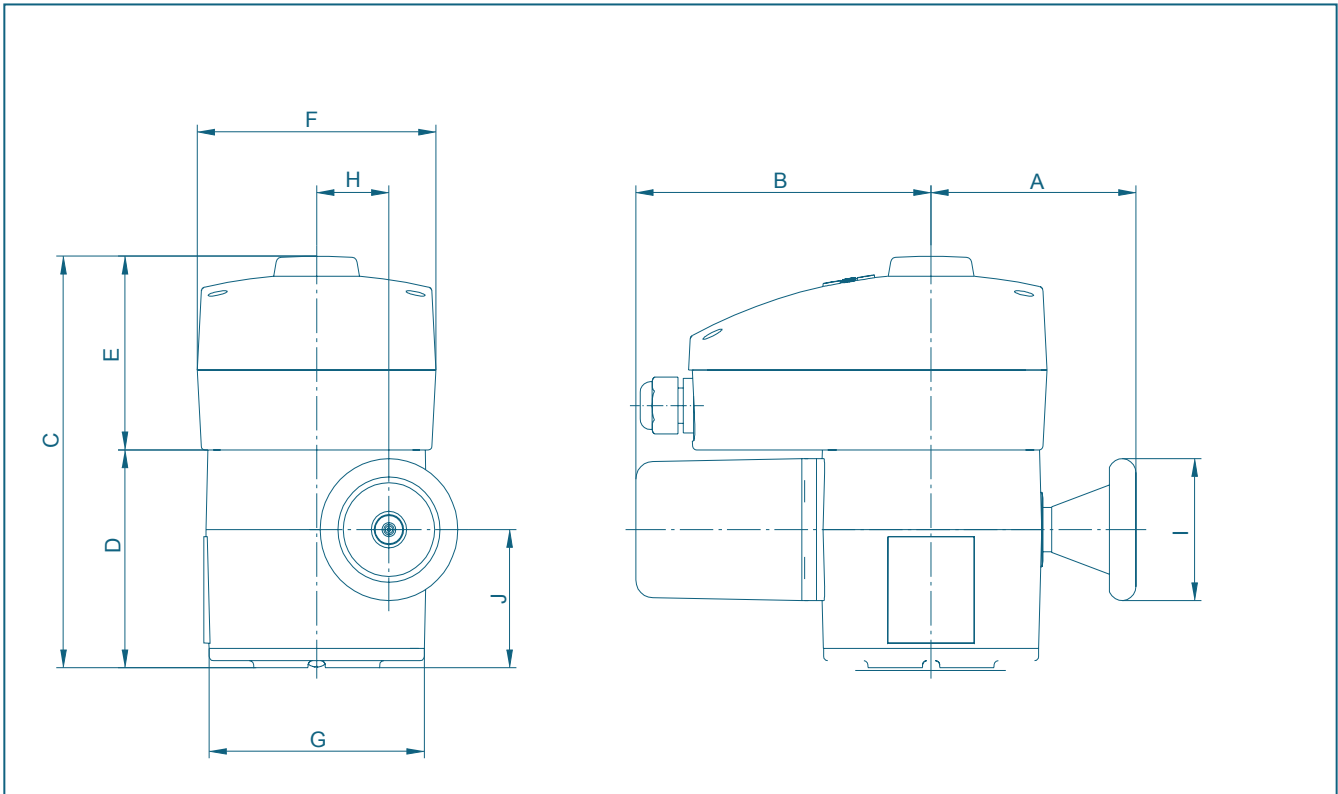

Type	Dimensions [mm]										Weight [kg]
	A	B	C	D	E	F	G	H	I	J	
E 50	110	149	210	123	87	124	126	42	80	73	5
E 65	119	172	235	123	112	139	125	42	80	78	7
E 110	136	247	257	145	112	139	150	58	125	88	14
E 160	157	280	282	170	112	139	175	89	200	112	25
E 210	212	352	274	162	112	139	240	125	315	84	40

Subject to change without notice

## FEATURES

Valve interface: EN ISO 5211

Type	E 50 WS	E 65 WS	E 65 DS	E 65 GS	E 110 WS	E 110 DS	E 110 GS	E 160 WS	E 160 DS	E 160 GS	E 210 DS
<b>Actuation time from 0° - to 90°</b>	25 s	6 s	6 s	6 s	12 s	12 s	6 s	24 s	24 s	12 s	24 s
<b>Rated torque</b>	40 Nm	100 Nm	100 Nm	100 Nm	400 Nm	400 Nm	360 Nm	1000 Nm	1000 Nm	800 Nm	3500 Nm
<b>Rated current</b>	0,15 A	0,7 A	0,3 A	5 A	1,3 A	1,0 A	8,8 A	1,3 A	1,0 A	8,8 A	1 A
<b>Starting current</b>	0,18 A	1,0 A	0,3 A	8,0 A	2 A	1,8 A	12,5 A	2 A	1,8 A	12,5 A	3,2 A
<b>Power consumption</b>	0,04 kW	0,16 kW	0,09 kW	0,08 kW	0,26 kW	0,22 kW	0,4 kW	0,26 kW	0,22 kW	0,4 kW	0,54 kW
<b>Rated voltage</b>	230 V	230 V	400 V	24 V	230 V	400 V	24 V	230 V	400 V	24 V	400 V
<b>*Frequency</b>	50 Hz	50 Hz	50 Hz	-	50 Hz	50 Hz	-	50 Hz	50 Hz	-	50 Hz
<b>Duty cycle</b>	30 %	30 %	30%	30%	30%	30%	30 %	30%	30%	30%	30%
<b>Protection class</b>	IP 67	IP 67	IP 67	IP 67	IP 67	IP 67	IP 67	IP 67	IP 67	IP 67	IP 67

\*Frequency 60 Hz upon request

# OPTIONS

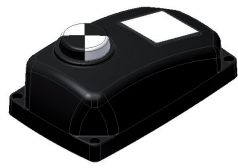

Cover plate with position indicator (E 50)



Cover plate with position indicator (E 65 - E 210)

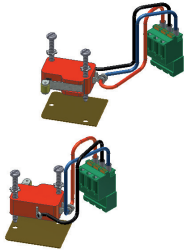

Additional volt-free limit switches

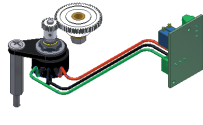

Current feedback 4-20 mA



Potentiometer 1000  $\Omega$

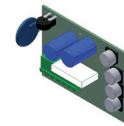

Torque control

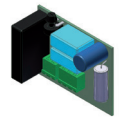

Timer



Conector terminals

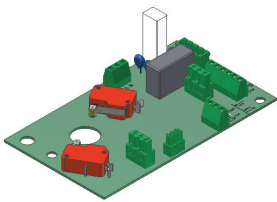

E 50 - 230 V AC

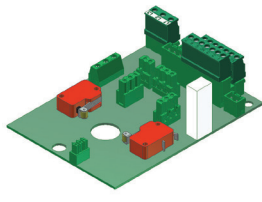

400 V AC

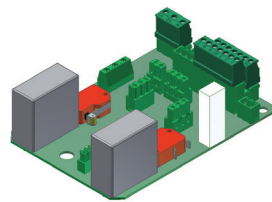

230 V AC

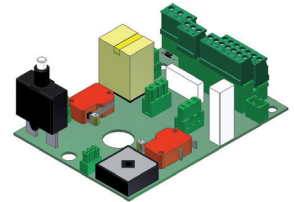

24 V DC



Switch box with cable glands



E 50



E 65



E 110



E 160



E 210

# CERTIFICATE

## EG – Declaration of conformity



We,

**EBRO ARMATUREN**  
**Gebr. Bröer GmbH, Karlstraße 8, 58135 Hagen, Deutschland**

declare in our sole responsibility, that our quarter-turn actuators of the E - series

<b>E50 WS</b>	<b>E 65 WS</b>	<b>E 110 WS</b>	<b>E 160 WS</b>	
	<b>E 65 DS</b>	<b>E 110 DS</b>	<b>E 160 DS</b>	<b>E 210 DS</b>
	<b>E 65 GS</b>	<b>E 110 GS</b>	<b>E 160 GS</b>	

and the enhanced unit box system

**M71-WS-XXX-40 und M71-DS-XXX-40 und M71-GS-XXX-40**

is this declaration is valid for, fulfil the requirements of following directives from council for harmonizing of member states of European community:

<b>Directive - 2006/95/EG -</b>	<b>Low voltage directive</b>
<b>Directive - 2004/108/EG -</b>	<b>EMC directive</b>
<b>Richtlinie - 2006/42/EG -</b>	<b>Machinery directive *</b>

(\* Electric actuators become considered according to machinery directive, article 2g, as an "incomplete machine", when they become delivered with a mounted valve)

As manufacturer of these products, we declare additionally, that following standards according to above listed directives have been consulted.

<b>EN 50178 : 1997</b>	
<b>EN 61010 -1 : 2010</b>	<b>for low-voltage directive</b>
<b>EN 61000-6-2 : 2005</b>	
<b>EN 61000-6-3 : 2007</b>	
<b>+ A1 : 2011</b>	<b>for electromagnetic compatibility (EMC)</b>
<b>EN 12100 : 2010</b>	
<b>EN ISO 5211 : 2001</b>	<b>für die machinery directive</b>

Responsible employee for documentation and required analysis is Mr. V. Pütz at headquarter of EBRO ARMATUREN.

All start-up procedures are not permitted till it is ensured, that the complete machine, in which EBRO quarter-turn actuators – or with valve- are installed, is in compliance with guidelines of EC-directive 2006/42/EG