

Data sheet collection. Differential Pressure Control Valve.

Data sheet „Differential Pressure Control Valve“, Issue 1121

Table of Contents

Differential pressure controller with adjustable setpoint 5-30kPa, 25-60kPa	2
Differential pressure controller with adjustable setpoint 50-150 kPa	20
Differential pressure controller with fixed setpoint (FIX)	31
Differential pressure controller with fixed setpoint and threaded connections for actuating drives (FIX TS).....	37

General information

Intended Use

This product is only intended for the use intended by the manufacturer, which is described in the section «Functional Description». This also includes compliance with all associated product regulations. Changes or modifications are not permitted.

Disposal

Local and currently valid legislation must be observed for disposal.

Advert

All schemes are symbolic and do not claim to be complete.

Material

Pursuant to Article 33 of the REACH Regulation (EC No. 1907/2006), we are obliged to point out that the material lead is listed on the SVHC list and that all brass components manufactured in our products exceed 0.1% (w/w) lead (CAS: 7439-92-1 / EINECS: 231-100-4). Since lead is a component part of an alloy, actual exposure is not expected and therefore no additional information on safe use is necessary.

All information, diagrams and drawings contained in this document are in accordance with the information available at the time of printing and are for information purposes only. Changes in the sense of technical progress are reserved. All schemes have symbolic character and make no claim to completeness. The illustrations are symbolic representations and therefore may differ optically from the actual products. Possible colour deviations are due to printing technology. Country-specific product deviations are possible. Subject to change of technical specifications and function. If you have any questions, please contact the nearest HERZ office.

HERZ Differential pressure controller with adjustable setpoint (5-30 kPa; 25-60 kPa)

Data sheet 1 4X02 XX

☑ Dimensions in mm

1 4202 XX

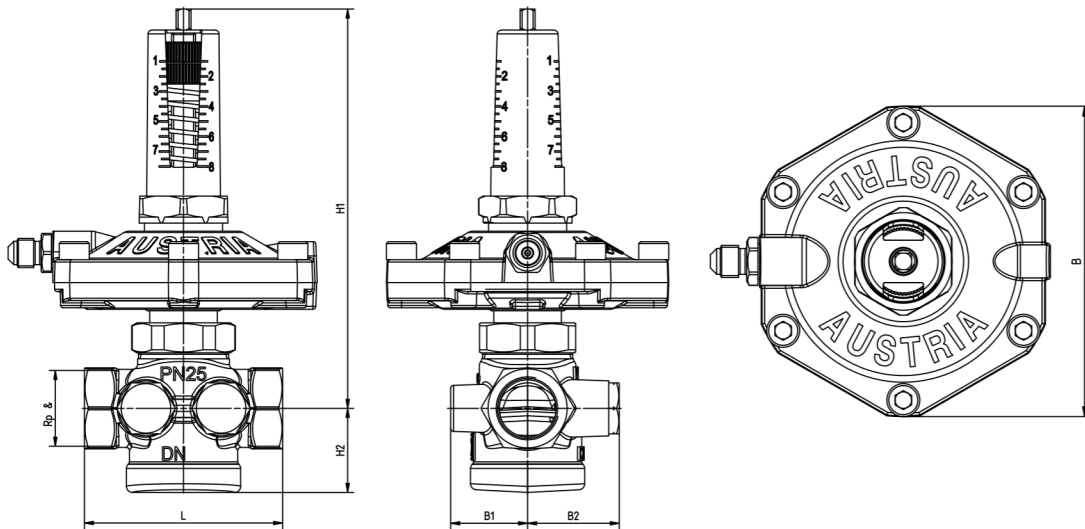

1 4002 XX

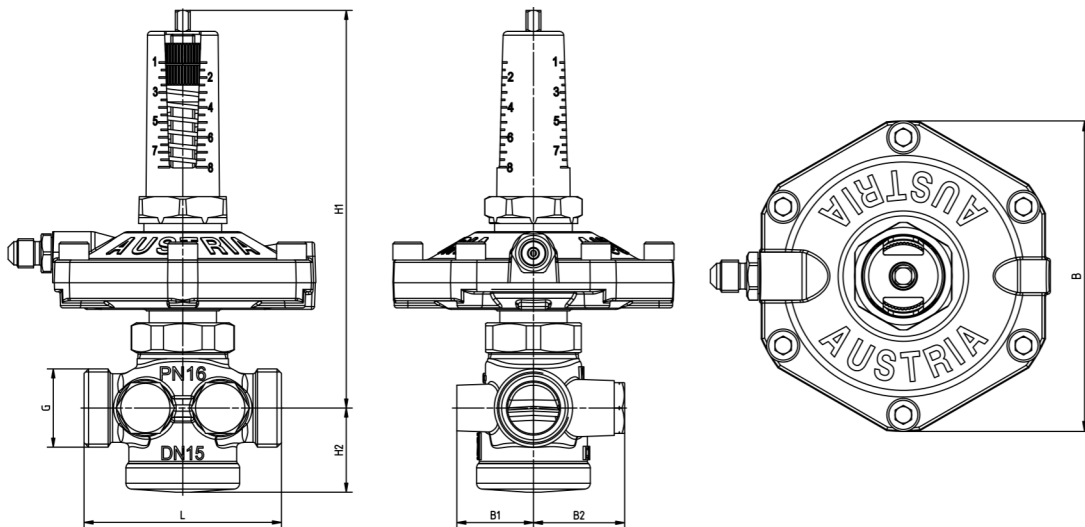

dP	DN	Item	Thread, in	L, mm	H1, mm	H2, mm	B, mm	B1, mm	B2, mm	
5-30 kPa	DN15	1 4002 41	MT	3/4 G	66	133	28	94	26	31
	DN20	1 4002 42		1 G	76	134	29	94	28	33
	DN25	1 4002 43		5/4 flat sealing	76	134	29	94	28	33
	DN32	1 4002 44		1 1/2 flat sealing	114	150	47	94	32	32
	DN40	1 4002 45		1 3/4 flat sealing	132	160	58	94	41	41
	DN50	1 4002 46		2 3/8 flat sealing	140	160	58	94	41	41
25-60 kPa	DN15	1 4002 61	MT	3/4 G	66	133	28	94	26	31
	DN20	1 4002 62		1 G	76	134	29	94	28	33
	DN25	1 4002 63		5/4 flat sealing	76	134	29	94	28	33
	DN32	1 4002 64		1 1/2 flat sealing	114	150	47	94	32	32
	DN40	1 4002 65		1 3/4 flat sealing	132	160	58	94	41	41
	DN50	1 4002 66		2 3/8 flat sealing	140	160	58	94	41	41
5-30 kPa	DN15	1 4202 41	FT	1/2	66	133	28	94	26	31
	DN20	1 4202 42		3/4	76	134	29	94	28	33
	DN25	1 4202 43		1	90	134	29	94	28	33
	DN32	1 4202 44		5/4	114	150	46	94	32	32
	DN40	1 4202 45		1 1/2	132	160	57	94	41	41
	DN50	1 4202 46		2	140	160	57	94	41	41
25-60 kPa	DN15	1 4202 61	FT	1/2	66	133	28	94	26	31
	DN20	1 4202 62		3/4	76	134	29	94	28	33
	DN25	1 4202 63		1	90	134	29	94	28	33
	DN32	1 4202 64		5/4	114	150	46	94	32	32
	DN40	1 4202 65		1 1/2	132	160	57	94	41	41
	DN50	1 4202 66		2	140	160	57	94	41	41

☑ Technical Data

	DN15	DN20	DN25	DN32	DN40	DN50
k_{vs} value	2,66	4,36	5,38	9,48	14,95	14,95
Operating pressure	max. 16 bar (4002) max. 25 bar (4202)					
Max. operating pressure on the body	4 bar					
Min. operating temperature	2 °C (water); - 20 °C (frost protection)					
Max. permissible operating temperature	up to DN32: 130 °C DN40 - DN50: 110 °C					
Control set (see table above)	5 - 30 kPa 25 - 60 kPa					
Water quality	according to ÖNORM H 5195 and VDI 2035 The use of ethylene glycol and propylene glycol is permitted in a mixing ratio of 25 - 50% by volume.					

Material

No	Description	Material
1	Body	DZR Brass
2	Valve stem	Stainless steel 14301
3	Connection nut	Brass
4	Indicator sleeve	Plastic (red)
5	Adjusting spindle	Brass
6	Compression spring	Spring steel 14310 NS
7	Connection point	Brass
8	Membrane	EPDM
9	Membrane body	Brass
10	O-Ring	EPDM

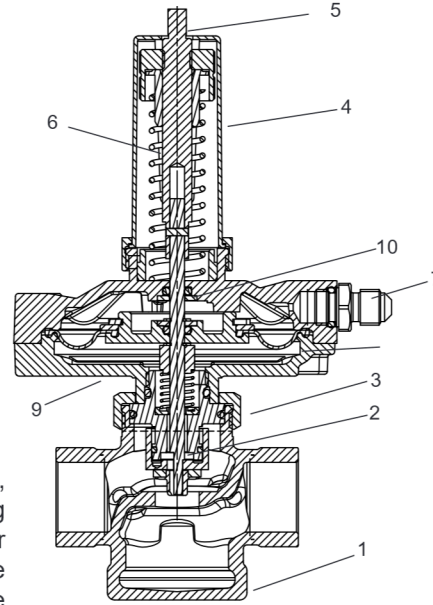

Ammonia contained in hemp damages brass valve housings, EPDM seals are swollen by mineral oils or lubricants containing mineral oils and thus lead to failure of the EPDM seals. For antifreeze and corrosion protection agents based on ethylene glycol and propylene glycol, the relevant information can be found in the manufacturer's documents.

Pursuant to Article 33 of the REACH Regulation (EC No. 1907/2006), we are obliged to point out that the material lead is listed on the SVHC list and that all brass components manufactured in our products exceed 0.1% (w/w) lead (CAS: 7439-92-1 / EINECS: 231-100-4). Since lead is a component part of an alloy, actual exposure is not expected and therefore no additional information on safe use is necessary.

Field of application

The Differential pressure controller is a straight-version linear controller and works without auxiliary power. The desired differential pressure setpoint can be adjusted between 5 and 30 kPa; 25 and 60 kPa. The set value can be read off using the setting diagram. The setpoint is set to minimum at the factory. The required setpoint is set with the pre-setting key (1 4006 02). A capillary (1000 mm) is included and should be connected to the regulating valve in the flow.

Installation

The valve is fitted in the return in any position. The arrow on the valve body should align with the direction of flow. It is recommended that an isolation valve is fitted both upstream and downstream of the differential pressure controller.

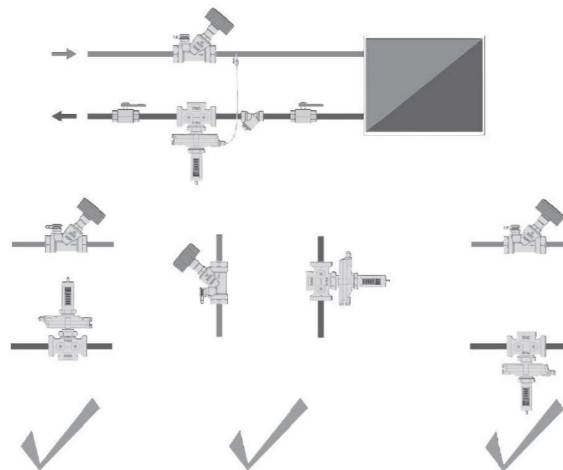

Function description

The differential pressure controllers are used to stabilize the differential pressure in heating and cooling circuits, which ensures that the heating consumer is independent of dynamic fluctuations in the riser. For the presetting of the differential pressure controller, the pressure loss ΔP of the riser (of the branch, of the system) is used.

The total pressure loss of the riser $\Sigma\Delta P_{riser}$ [kPa] is calculated using the following formula:

$$\Sigma\Delta P_{riser} = \Delta P_{riser} + \Delta P_{dP}$$

in which:

ΔP_{dP} - pressure loss of the DP controller. A minimum ΔP_{dP} of 10 kPa is recommended for optimal function.

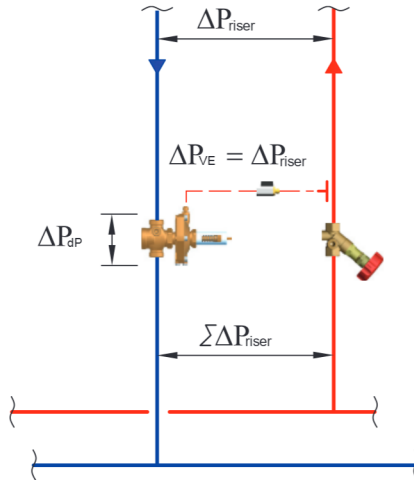

Setting

The controller is set to minimum at the factory. The setting is made by turning the knurled nut. The differential pressure controller can be set in any position. The respective setting of the controller is clearly displayed.

Example: Desired differential pressure $\Delta P_{riser} = 40$ kPa (400 mbar)
 Flow rate 1000 l/h.
 Setting value on scale 4

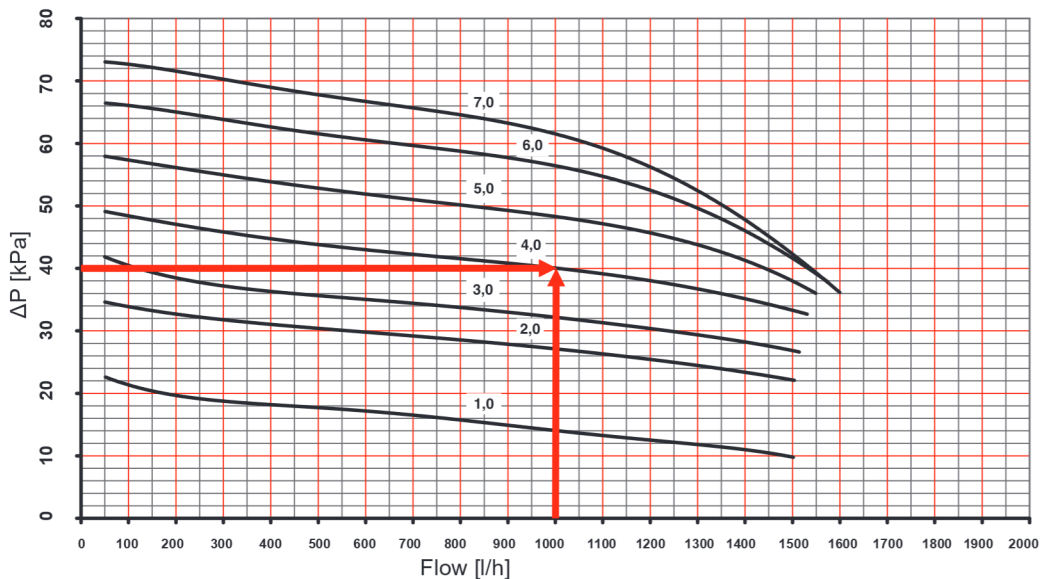

☑ **Warning notices**





The valves must be installed for the correct application using clean fittings. A HERZ strainer (4111) should be fitted to prevent impurities.

☑ **Test points**

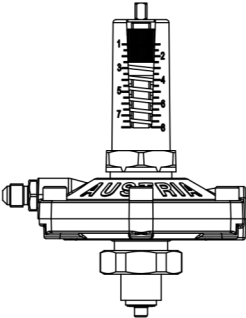
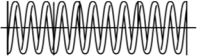
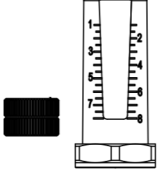
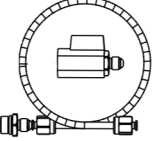
Two test points are fitted next to each other. This arrangement ensures the best accessibility and optimal connection of measuring devices in all installation positions.

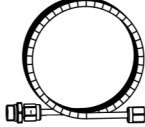
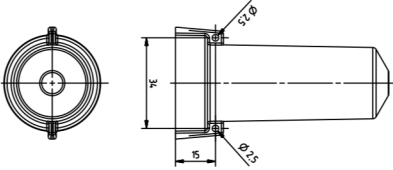
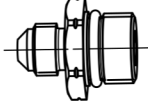
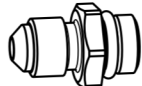
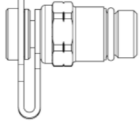
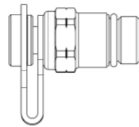
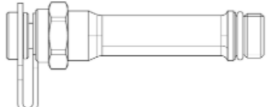
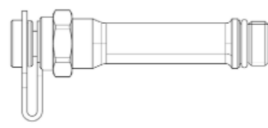
☑ **Accessories and spare parts**

Item	Dim.	Description	Image
1 4096 11	DN15	Insulation shells EPP (expanded polypropylene), color anthracite / black or silver-gray, B2 according to DIN 4102 and E according to DIN EN 13501-1, density approx. 45 kg/m ³ , integrated geometric lock. For the differential pressure controller 4002/4202.	
1 4096 12	DN20		
1 4096 13	DN25		
1 4096 14	DN32		
1 4096 15	DN40		
1 4096 16	DN50		
1 6386 91	-	Replacement upper part 1 4X02 41	
1 6386 92	-	Replacement upper part 1 4X02 42	
1 6386 93	-	Replacement upper part 1 4X02 43	
1 6386 94	-	Replacement upper part 1 4X02 44	
1 6386 95	-	Replacement upper part 1 4X02 45- 46	
1 6386 96	-	Replacement upper part 1 4X02 61	
1 6386 97	-	Replacement upper part 1 4X02 62	
1 6386 98	-	Replacement upper part 1 4X02 63	
1 6386 99	-	Replacement upper part 1 4X02 64	
1 6387 00	-	Replacement upper part 1 4X02 65 - 66	
1 4002 97	DN15–50	5–30 kPa Replacement string 4002 / 4202	
1 4002 98	DN15–50	25–60 kPa Replacement string 4002 / 4202	
1 4002 99	DN15–50	45–80 kPa Replacement string 4002 / 4202	
1 4002 10	DN15–50	Indicator sleeve for HERZ differential pressure controller 4002/4202	
1 4002 78	1,0 m	Capillary for differential pressure controller with ball valve 1/8 ".	

1 4002 80	2,0 m	Capillary for differential pressure controller with ball valve 1/8 " G x 1/4" G.	
1 6502 10	DN15-DN50	HERZ adjustment lock for HERZ differential pressure controller 4002, 4202. Material black plastic, with openings for attaching a seal and seal wire included. Sales unit 20 pcs.	
1 0269 19	1/8" x 1/4"	Connection point for capillary	
1 0269 09	1/8" x 1/8"	Connection point for capillary	
1 0284 01	1/4"	Quick test point for HERZ regulating point, blue cap (return)	
1 0284 02	1/4"	Quick test point for HERZ regulating valve, red cap (return)	
1 0284 11	1/4"	Test point for HERZ regulating valve, extended design, blue cap (return)	
1 0284 12	1/4"	Test point for HERZ regulating valve, extended design, red cap (supply)	
1 0284 21	1/4"	HERZ test point with drain valve, blue cap (return)	
1 0284 22	1/4"	HERZ test point with drain valve, red cap (supply)	
1 4006 02		Pre-setting key for HERZ differential pressure controller 4002/4202	

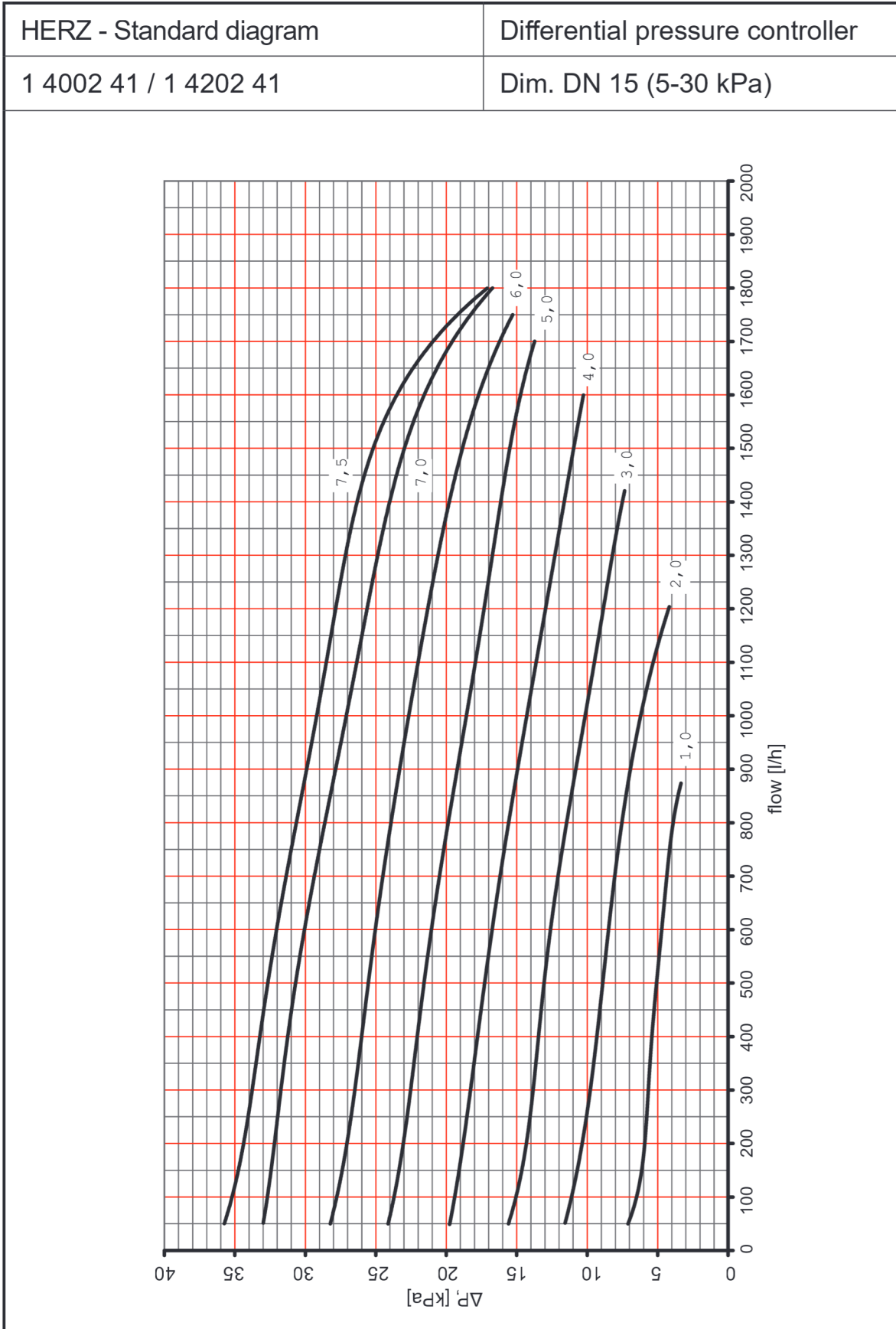

HERZ - Standard diagram	Differential pressure controller
1 4002 61 / 1 4202 61	Dim. DN 15 (25-60 kPa)

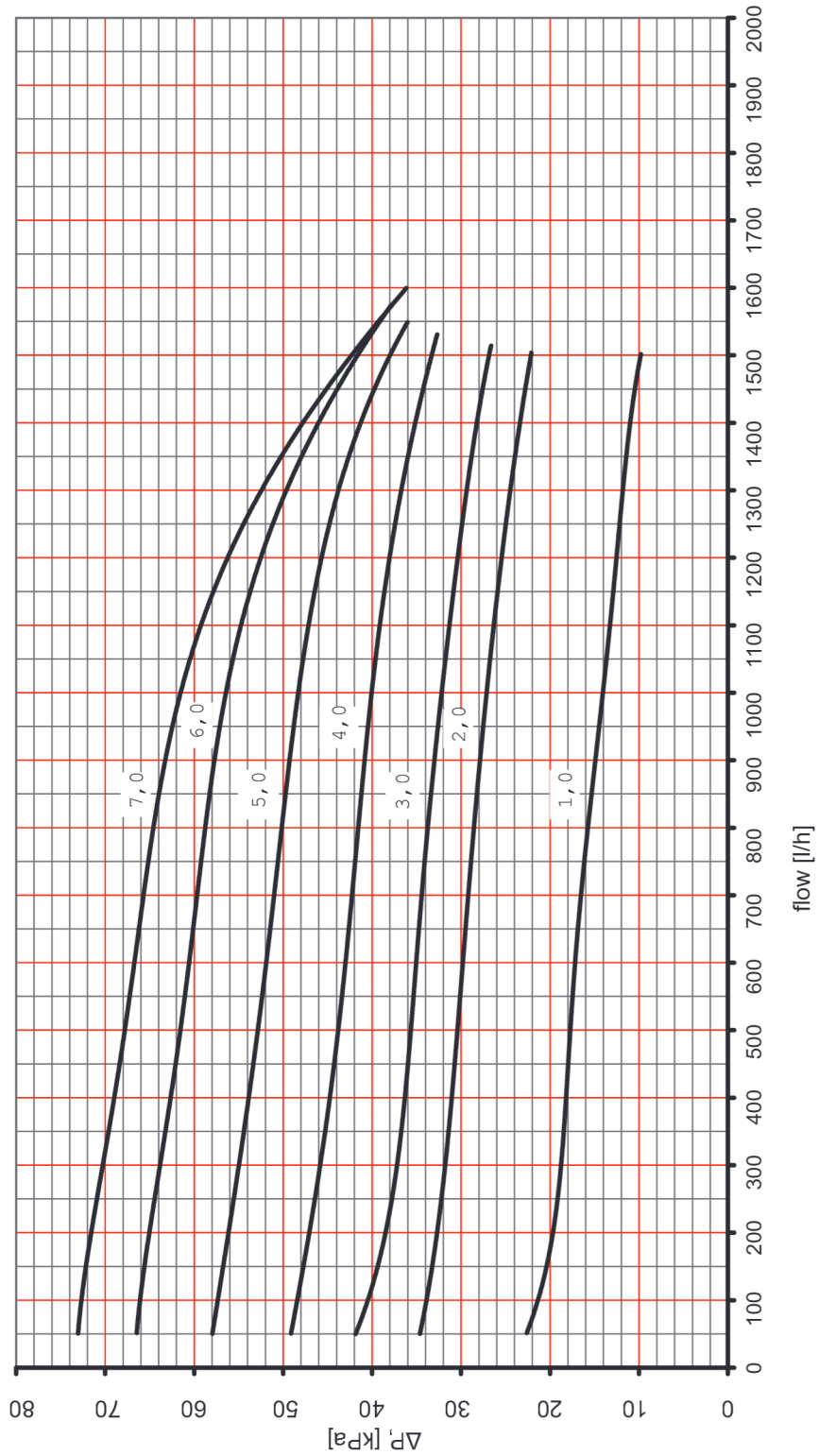

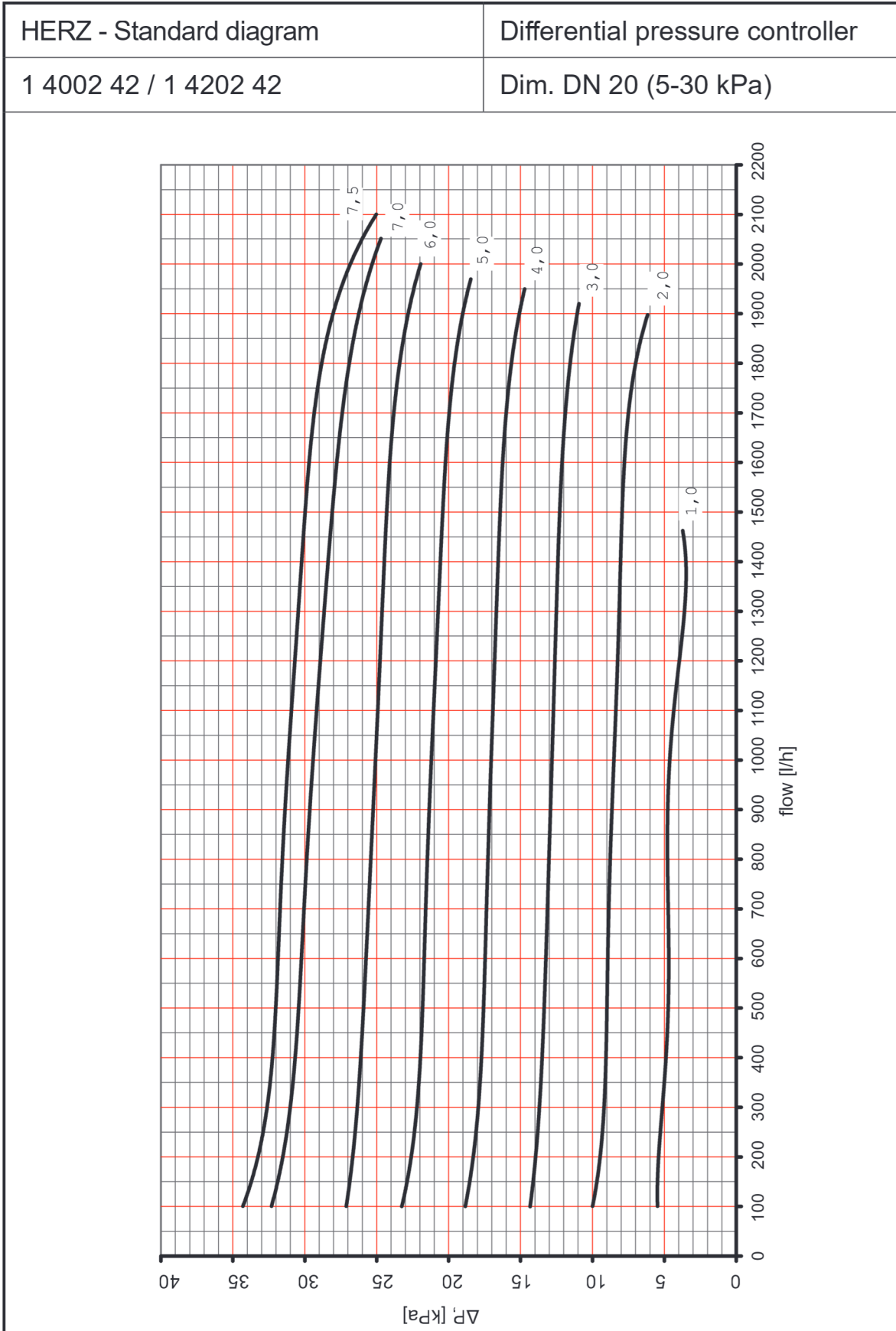

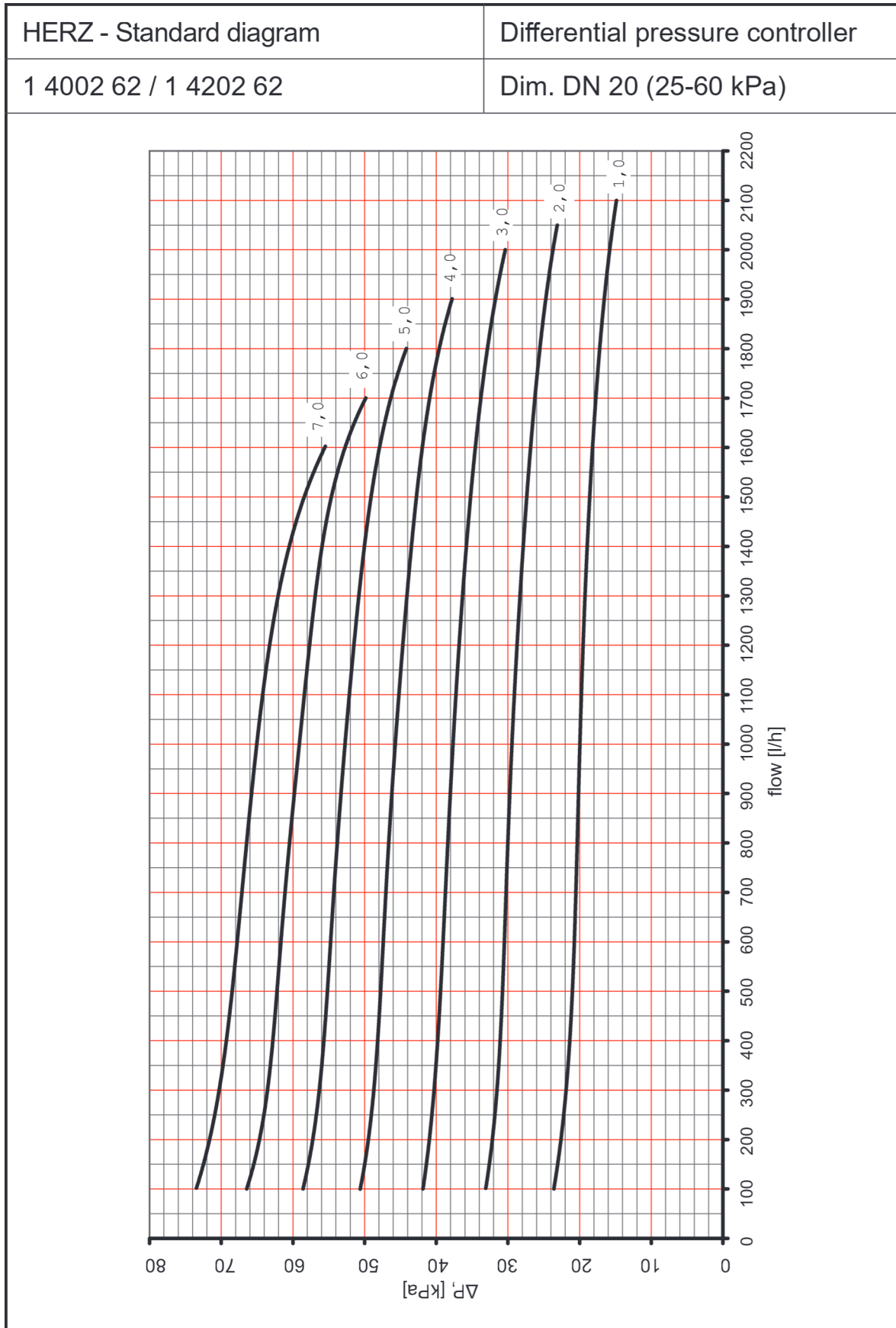

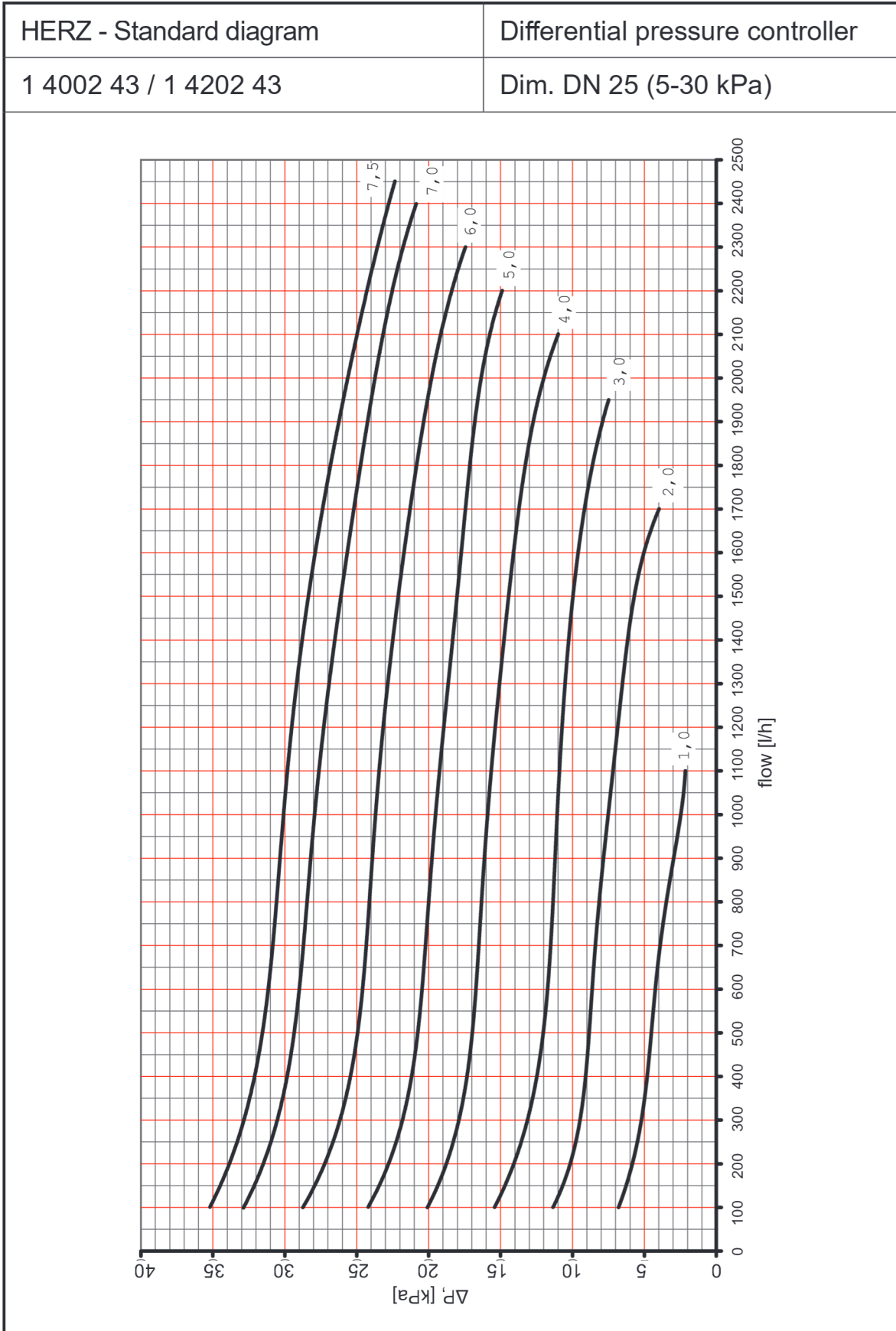

HERZ - Standard diagram	Differential pressure controller
1 4002 63 / 1 4202 63	Dim. DN 25 (25-60 kPa)

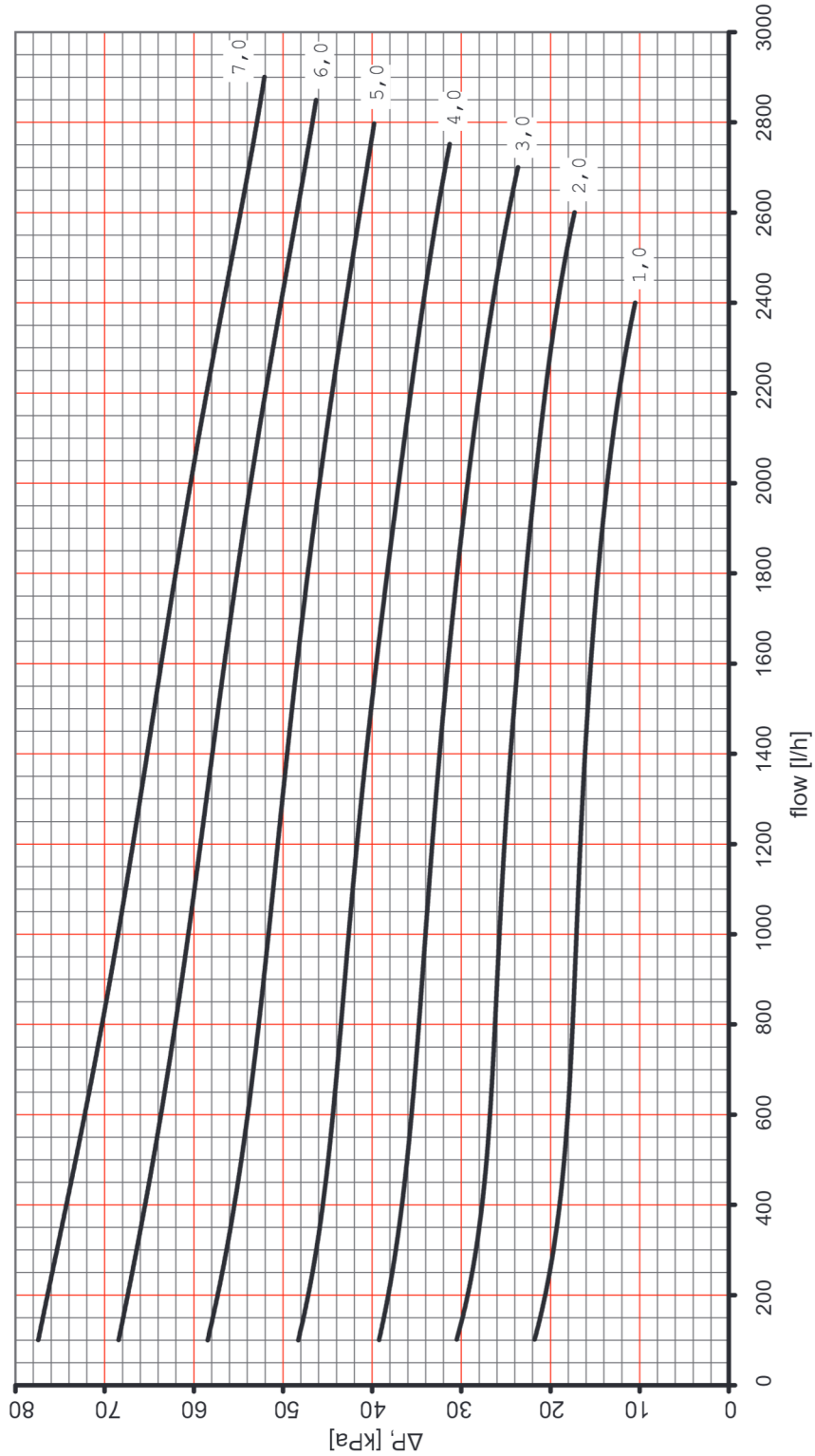

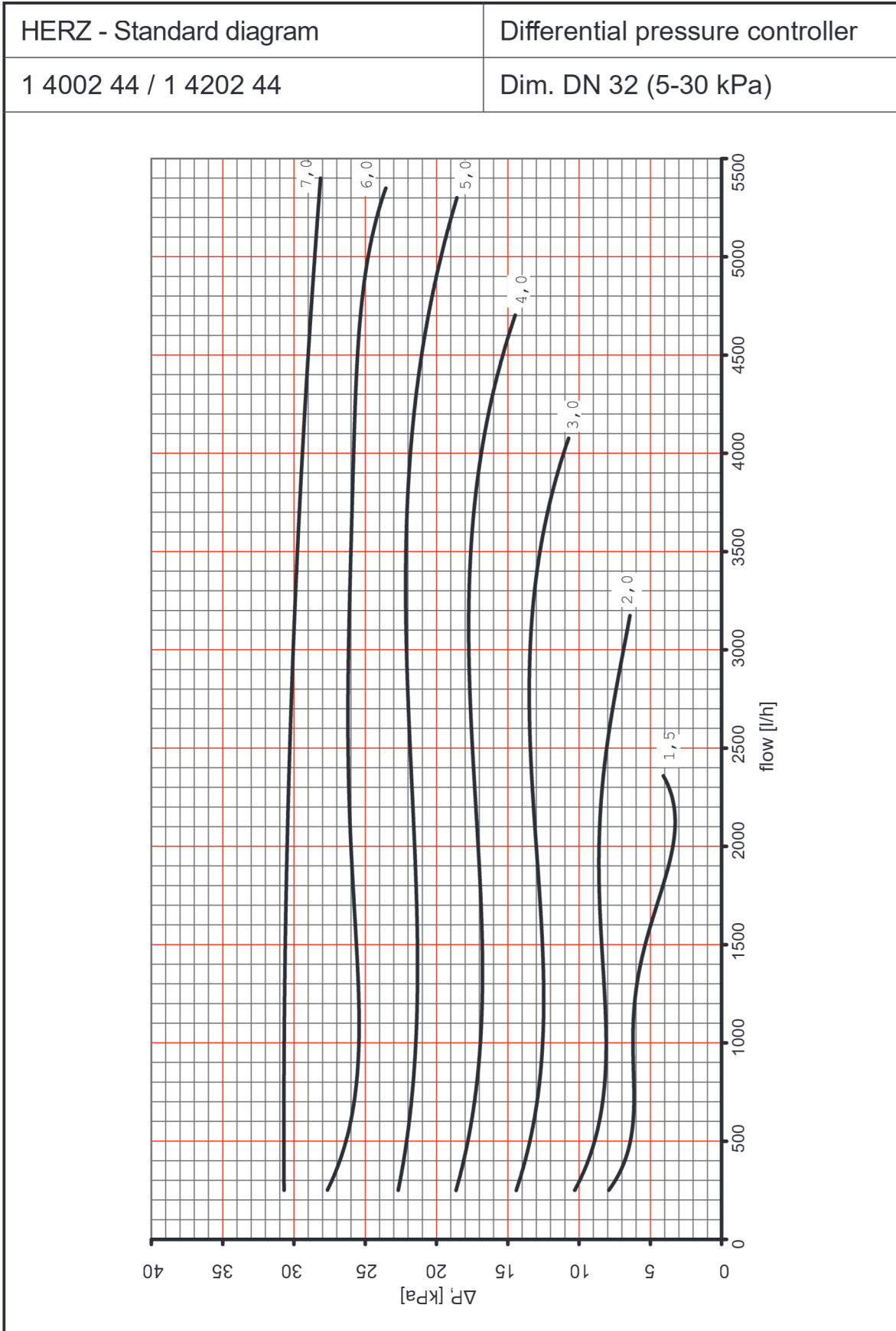

HERZ - Standard diagram	Differential pressure controller
1 4002 64 / 1 4202 64	Dim. DN 32 (25-60 kPa)

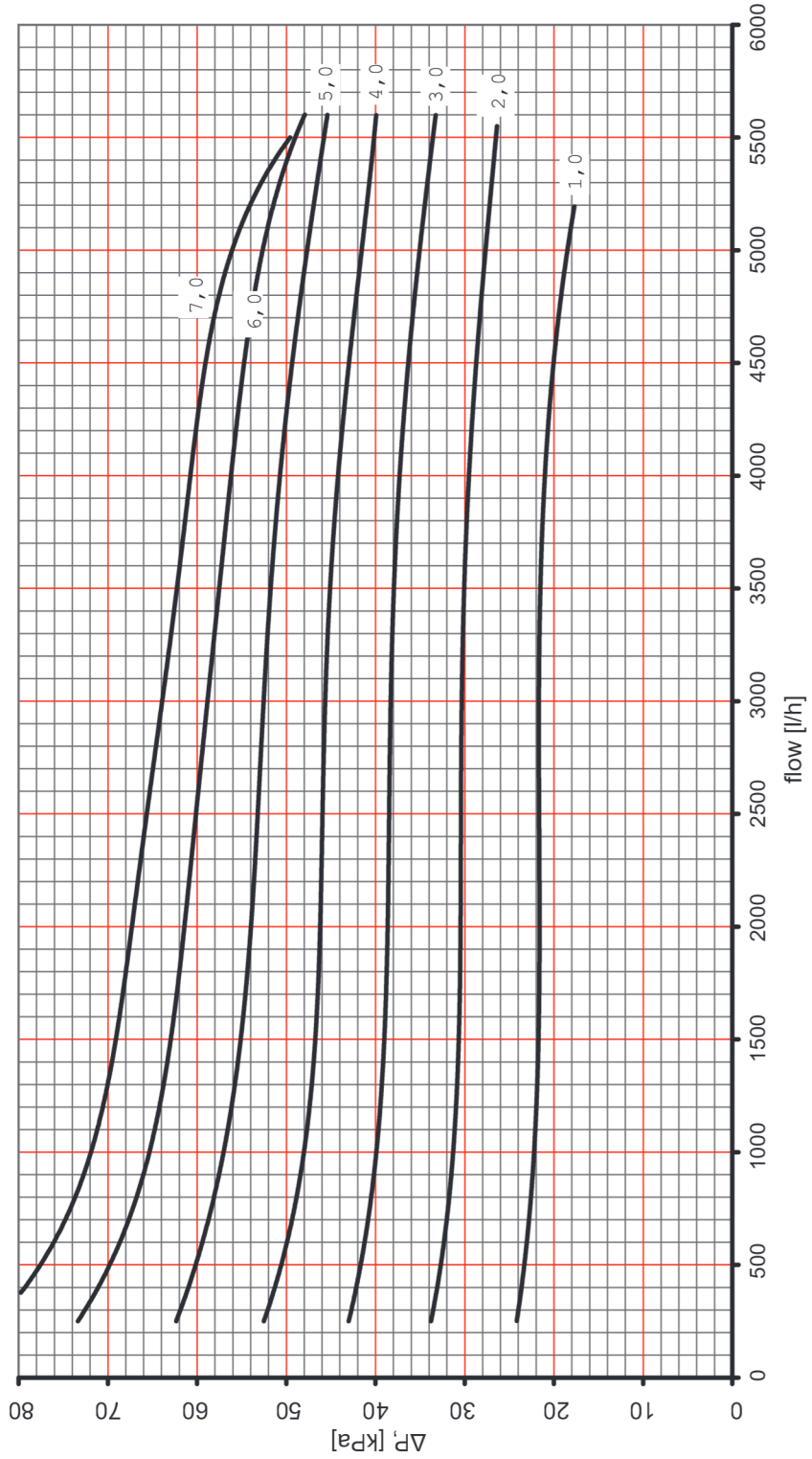

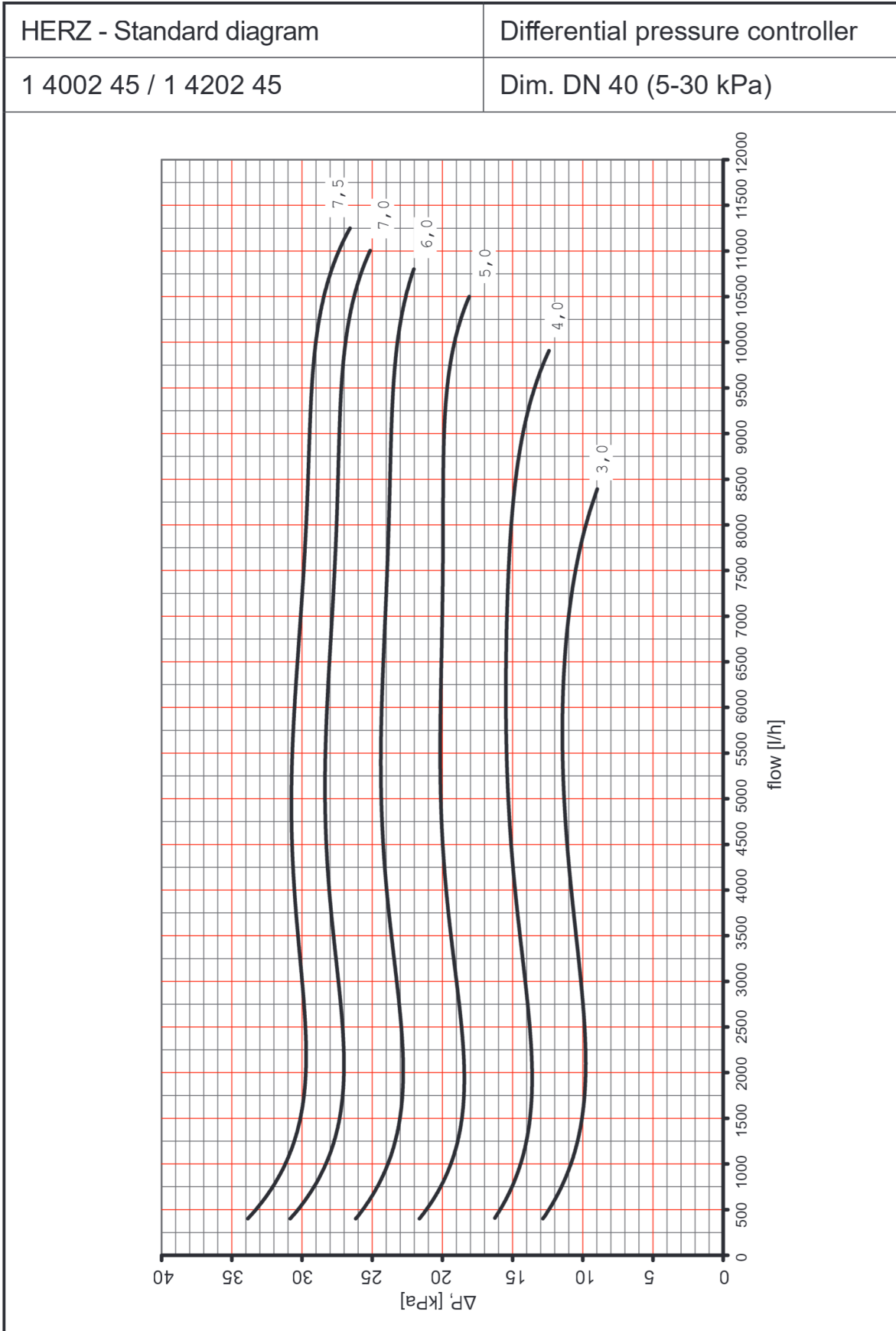

HERZ - Standard diagram	Differential pressure controller
1 4002 65 / 1 4202 65	Dim. DN 40 (25-60 kPa)

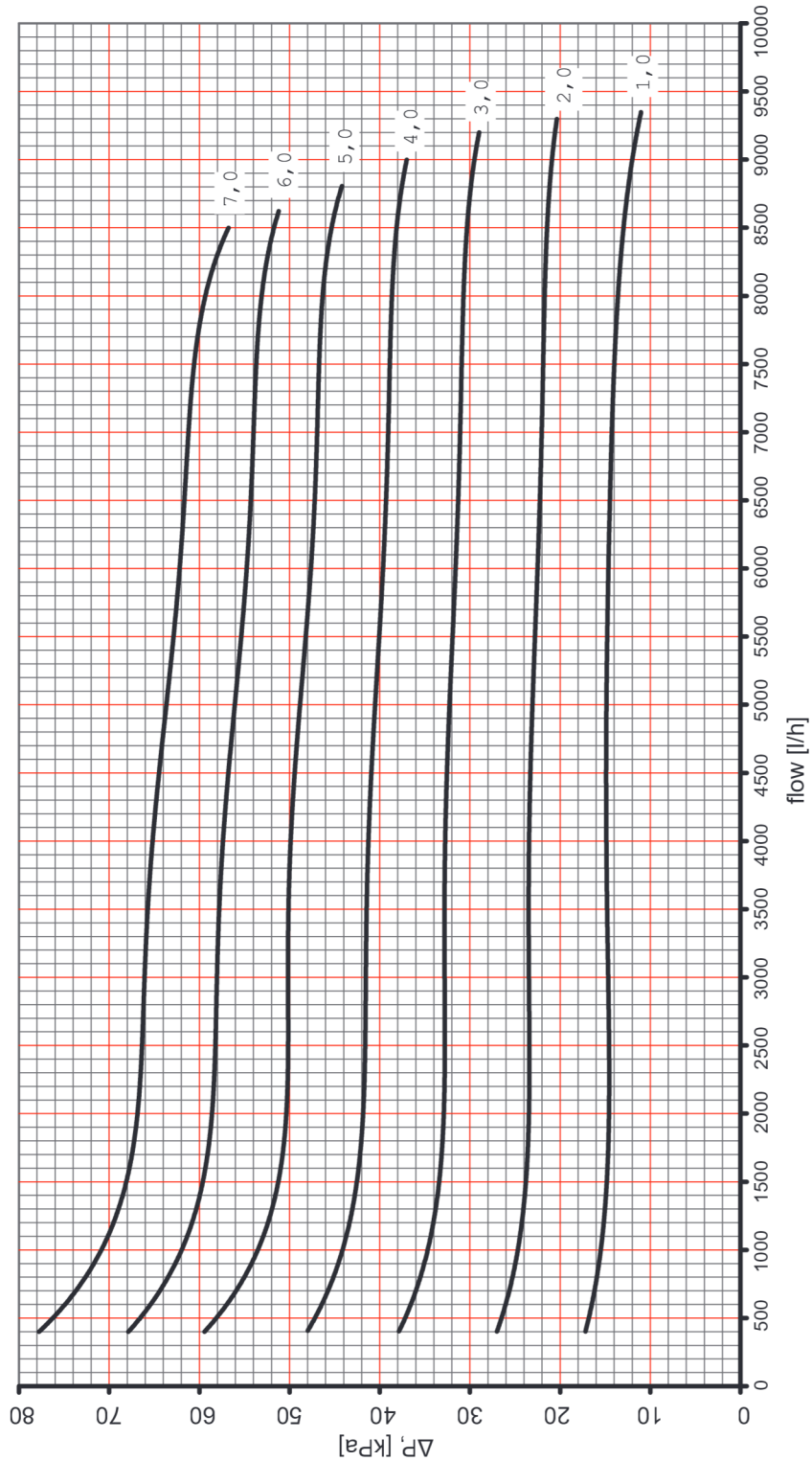

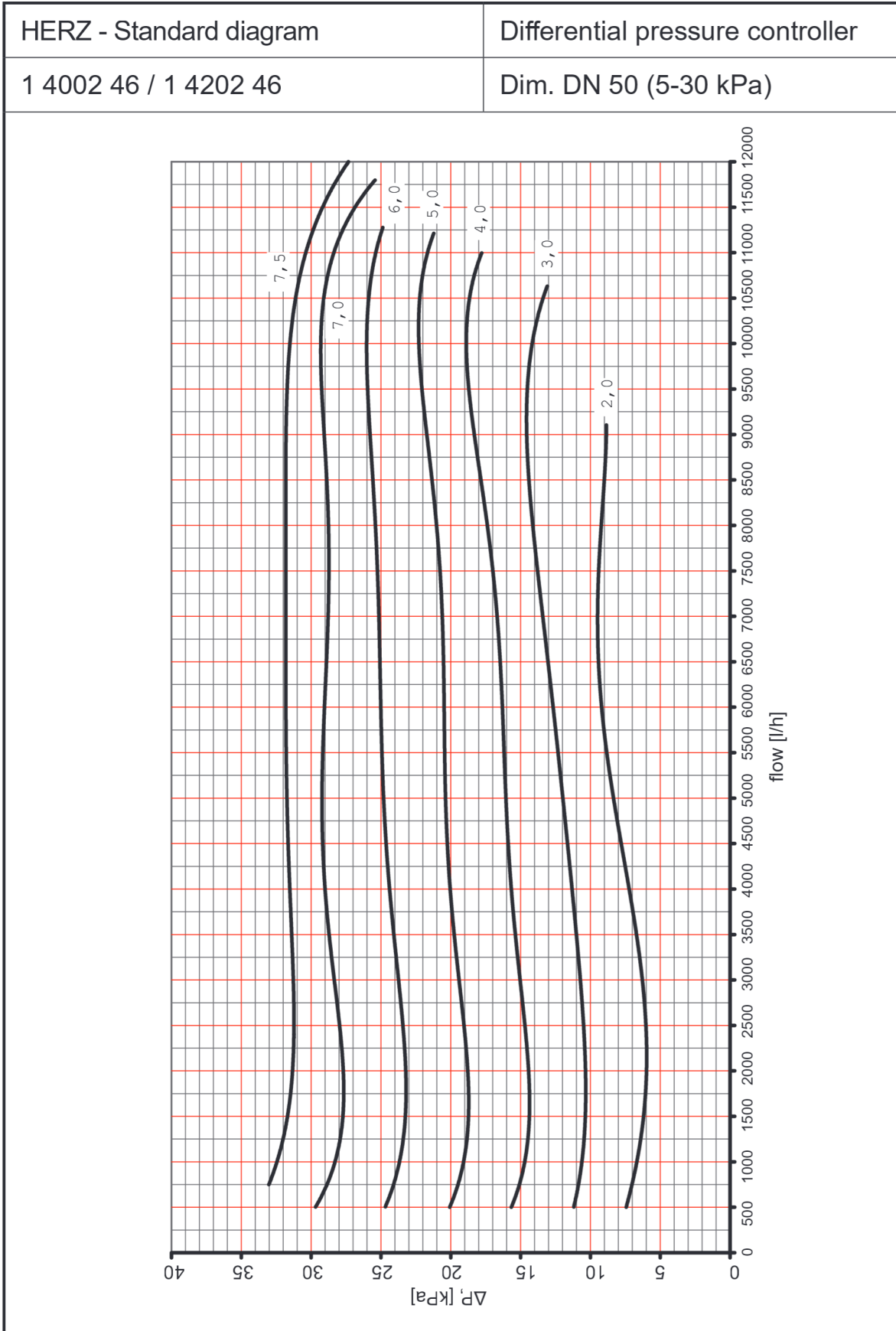

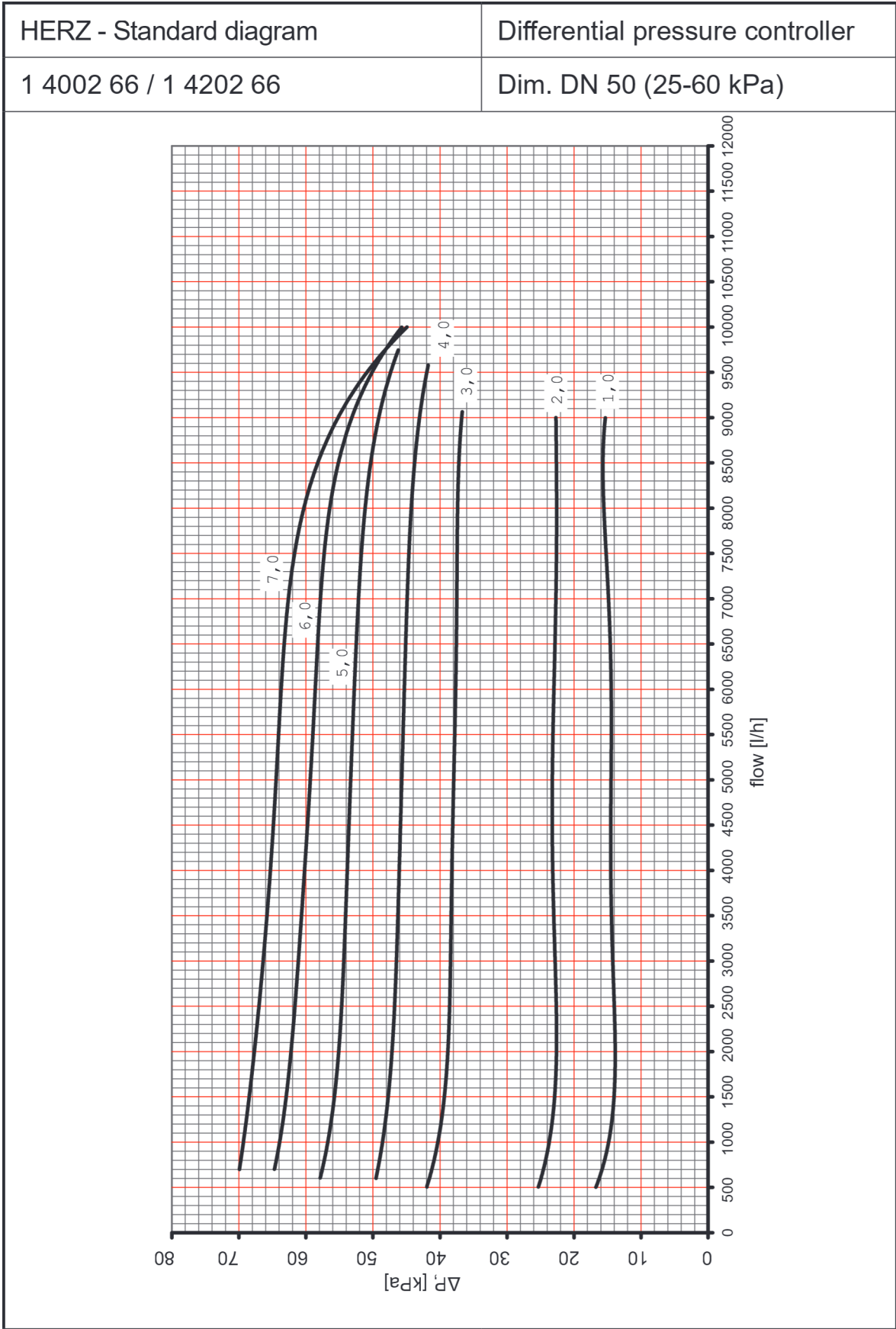

HERZ Differential pressure controller with adjustable setpoint (50-150 kPa)

Data sheet 1 4X02 3X

☑ Dimensions in mm

1 4002 3X

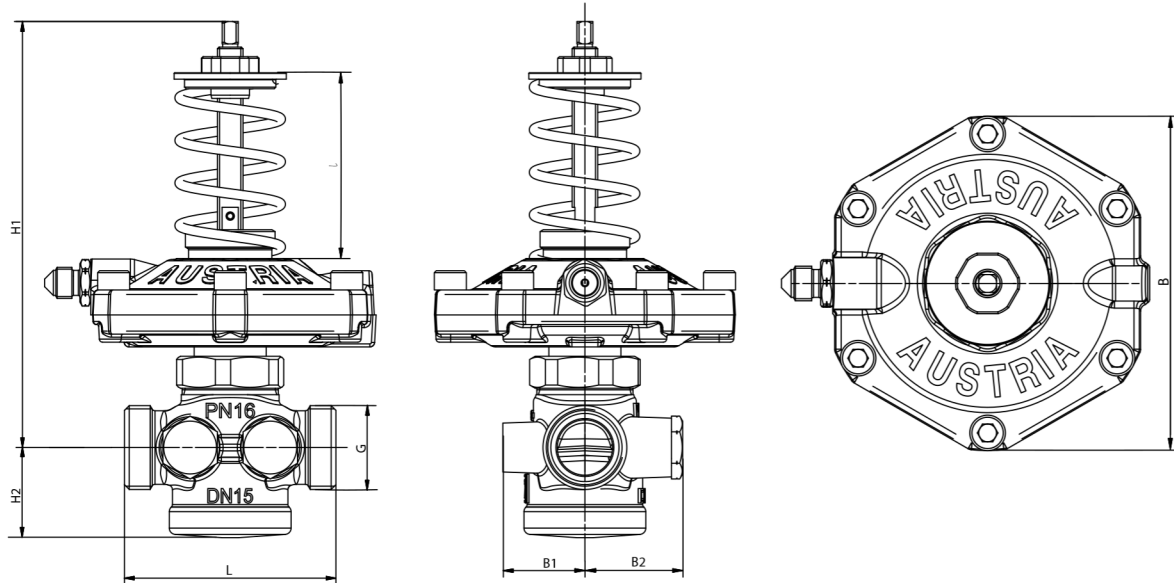
l - compression spring travel, mm

dP	DN	Item	Thread, in	L, mm	H1, mm	H2, mm	B, mm	B1, mm	B2, mm	
50-150 kPa	DN15	1 4002 31	AG	3/4 flat sealing	66	133	28	94	26	31
	DN20	1 4002 32		1 flat sealing	76	134	29	94	28	33
	DN25	1 4002 33		5/4 flat sealing	76	134	29	94	28	33
	DN32	1 4002 34		1 1/2 flat sealing	114	150	47	94	32	32
	DN40	1 4002 35		1 3/4 flat sealing	132	160	57	94	41	41
	DN50	1 4002 36		2 3/8 flat sealing	140	160	57	94	41	41

☑ Technical Data

	DN15	DN20	DN25	DN32	DN40	DN50
k_{VS} value	2,6	4,2	5,3	7,1	12,4	
Operating pressure	max. 16 bar					
Max. operating pressure on the body	4 bar					
Min. operating temperature	2 °C (water); - 20 °C (frost protection)					
Max. permissible operating temperature	up to DN32: 130 °C DN40 - DN50: 110 °C					
Differential pressure regulation range	50 - 150 kPa					
Water quality	according to ÖNORM H 5195 and VDI 2035 The use of ethylene glycol and propylene glycol is permitted in a mixing ratio of 25 - 50% by volume.					

☑ Material

N	Description	Material
1	Body	DZR Brass
2	Valve stem	Stainless steel 14301
3	Connection nut	Brass
4	O-Ring	EPDM
5	Adjusting spindle	Brass
6	Compression spring	Spring steel 14310
7	Connection point	Brass
8	Membrane	EPDM
9	Membrane body	Brass

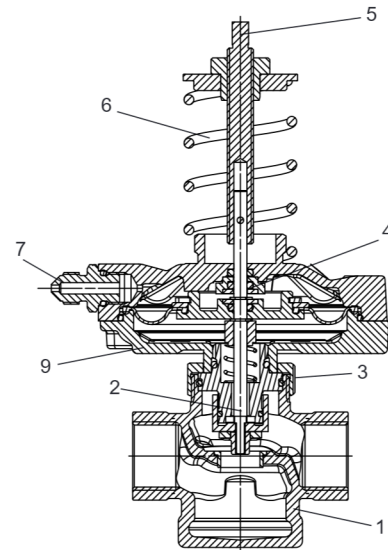

Ammonia contained in hemp damages brass valve housings, EPDM seals are swollen by mineral oils or lubricants containing mineral oils and thus lead to failure of the EPDM seals. For antifreeze and corrosion protection agents based on ethylene glycol and propylene glycol, the relevant information can be found in the manufacturer's documents.

Pursuant to Article 33 of the REACH Regulation (EC No. 1907/2006), we are obliged to point out that the material lead is listed on the SVHC list and that all brass components manufactured in our products exceed 0.1% (w/w) lead (CAS: 7439-92-1 / EINECS: 231-100-4). Since lead is a component part of an alloy, actual exposure is not expected and therefore no additional information on safe use is necessary.

☑ Field of application

The Differential pressure controller is a straight-version linear controller and works without auxiliary power. The desired differential pressure setpoint can be adjusted between 50 and 150 kPa. The set value can be read off using the setting diagram. The setpoint is set to minimum at the factory ($l = 65$ mm). The required setpoint is set with the pre-setting key (1 **4006 02**). A capillary (1000 mm) is included and should be connected to the regulating valve in the flow.

☑ Installation

The valve is fitted in the return in any position. The arrow on the valve body should align with the direction of flow. It is recommended that an isolation valve is fitted both upstream and downstream of the differential pressure controller.

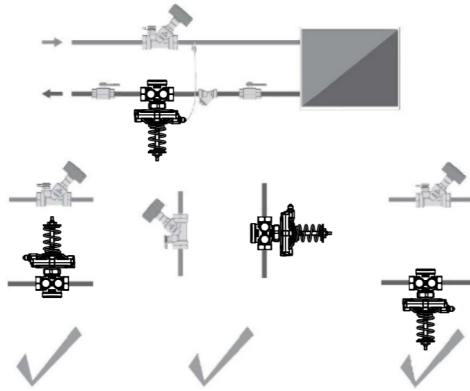

☑ Function description

The differential pressure controllers are used to stabilize the differential pressure in heating and cooling circuits, which ensures that the heating consumer is independent of dynamic fluctuations in the riser.

For the presetting of the differential pressure controller, the pressure loss ΔP of the riser (of the branch, of the system) is used.

The total pressure loss of the riser $\Sigma\Delta P_{\text{riser}}$ [kPa] is calculated using the following formula:

$$\Sigma\Delta P_{\text{riser}} = \Delta P_{\text{riser}} + \Delta P_{\text{dP}}$$

in which:

ΔP_{dP} - pressure loss of the DP controller. A minimum ΔP_{dP} of 10 kPa is recommended for optimal function.

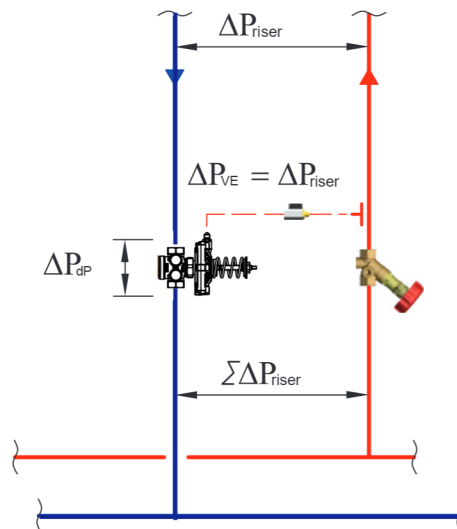

☑ Setting

The controller is set to minimum at the factory ($l = 65 \text{ mm}$). The setting is made by turning the adjusting spindle. This changes the compression spring travel (l). The differential pressure controller can be set in any position. The setting of the differential pressure controllers can be found in the setting diagram (see below).

Example: Desired differential pressure $\Delta P_{\text{Strang}} = 100 \text{ kPa}$ (1000 mbar)

Flow rate 1000 l/h.

Result: compression spring travel $l = 45 \text{ mm}$

The compression spring travel is to be measured according to the picture (see above).

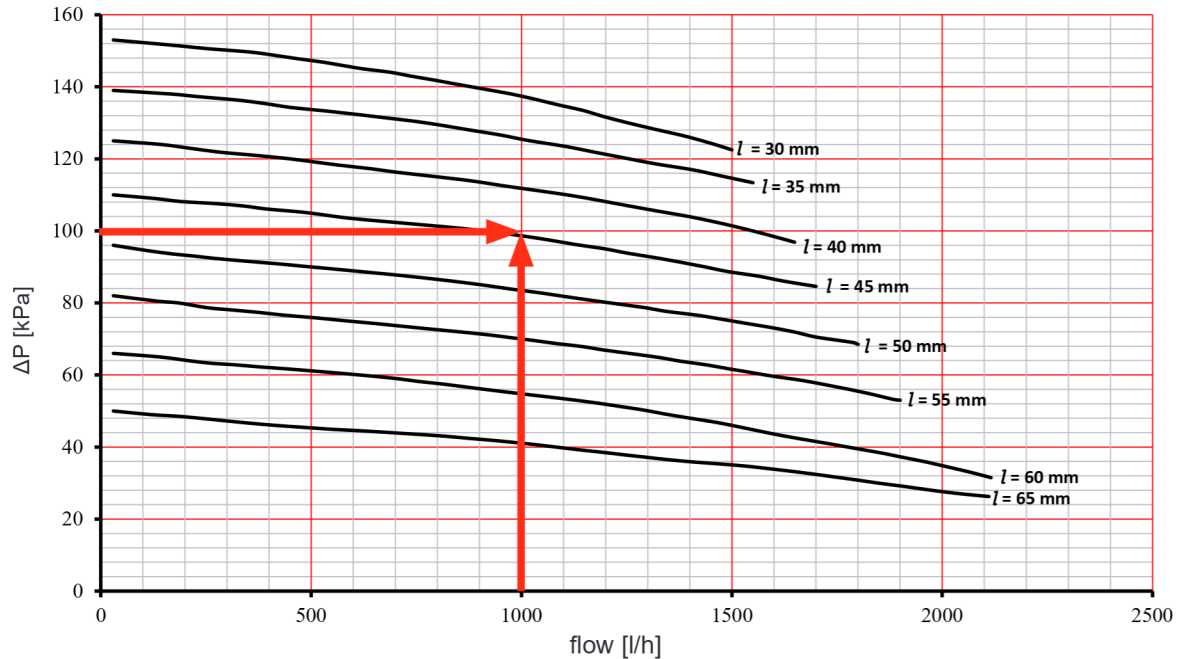

☑ Warning notices



The valves must be installed for the correct application using clean fittings. A HERZ strainer (4111) should be fitted to prevent impurities.

☑ Test points

Two test points are fitted next to each other. This arrangement ensures the best accessibility and optimal connection of measuring devices in all installation positions.

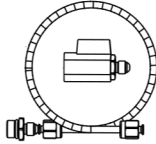
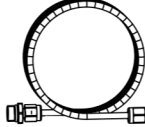
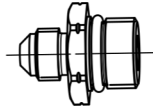
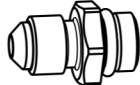
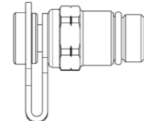
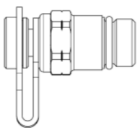
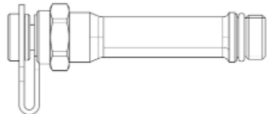
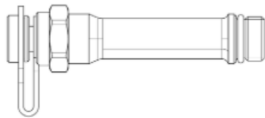
☑ Accessories and spare parts

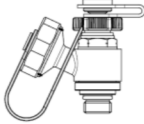
Item	Dim.	Description	Image
1 4096 11	DN15	Insulation shells EPP (expanded polypropylene), color anthracite / black or silver-gray, B2 according to DIN 4102 and E according to DIN EN 13501-1, density approx. 45 kg/m ³ , integrated geometric lock. For the differential pressure controller 4002/4202.	
1 4096 12	DN20		
1 4096 13	DN25		
1 4096 14	DN32		
1 4096 15	DN40		
1 4096 16	DN50		
1 4002 78	1,0 m	Capillary for differential pressure controller with ball valve 1/8 " .	
1 4002 80	2,0 m	Capillary for differential pressure controller with ball valve 1/8" G x 1/4" G.	
1 0269 19	1/8" x 1/4"	Connection point for capillary	
1 0269 09	1/8" x 1/8"	Connection point for capillary	
1 0284 01	1/4"	Quick test point for HERZ regulating point, blue cap (return)	
1 0284 02	1/4"	Quick test point for HERZ regulating valve, red cap (return)	
1 0284 11	1/4"	Test point for HERZ regulating valve, extended design, blue cap (return)	
1 0284 12	1/4"	Test point for HERZ regulating valve, extended design, red cap (supply)	

1 0284 21	1/4"	HERZ test point with drain valve, blue cap (return)	
1 0284 22	1/4"	HERZ test point with drain valve, red cap (supply)	
1 4006 02		Pre-setting key for HERZ differential pressure controller 4002/4202	

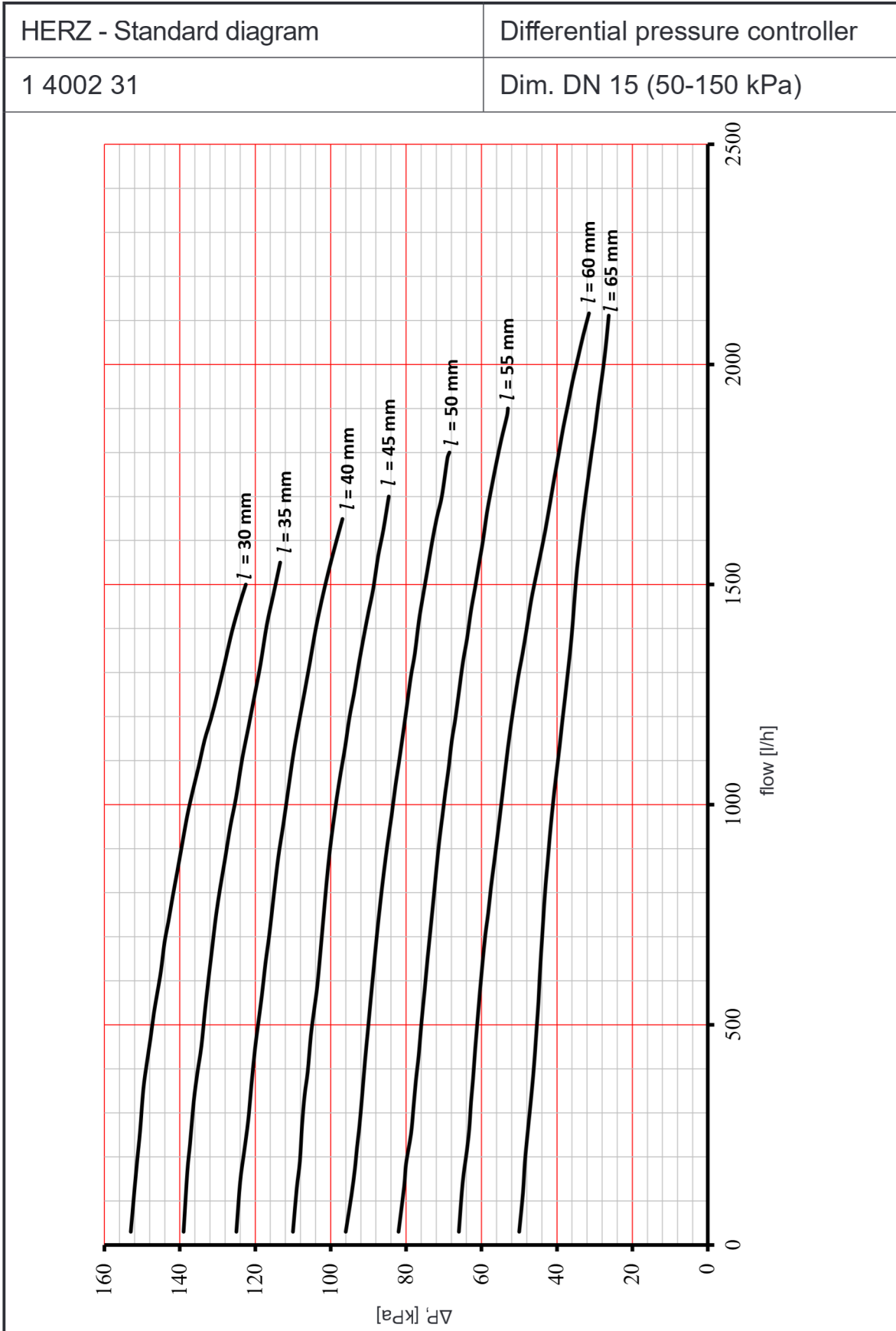

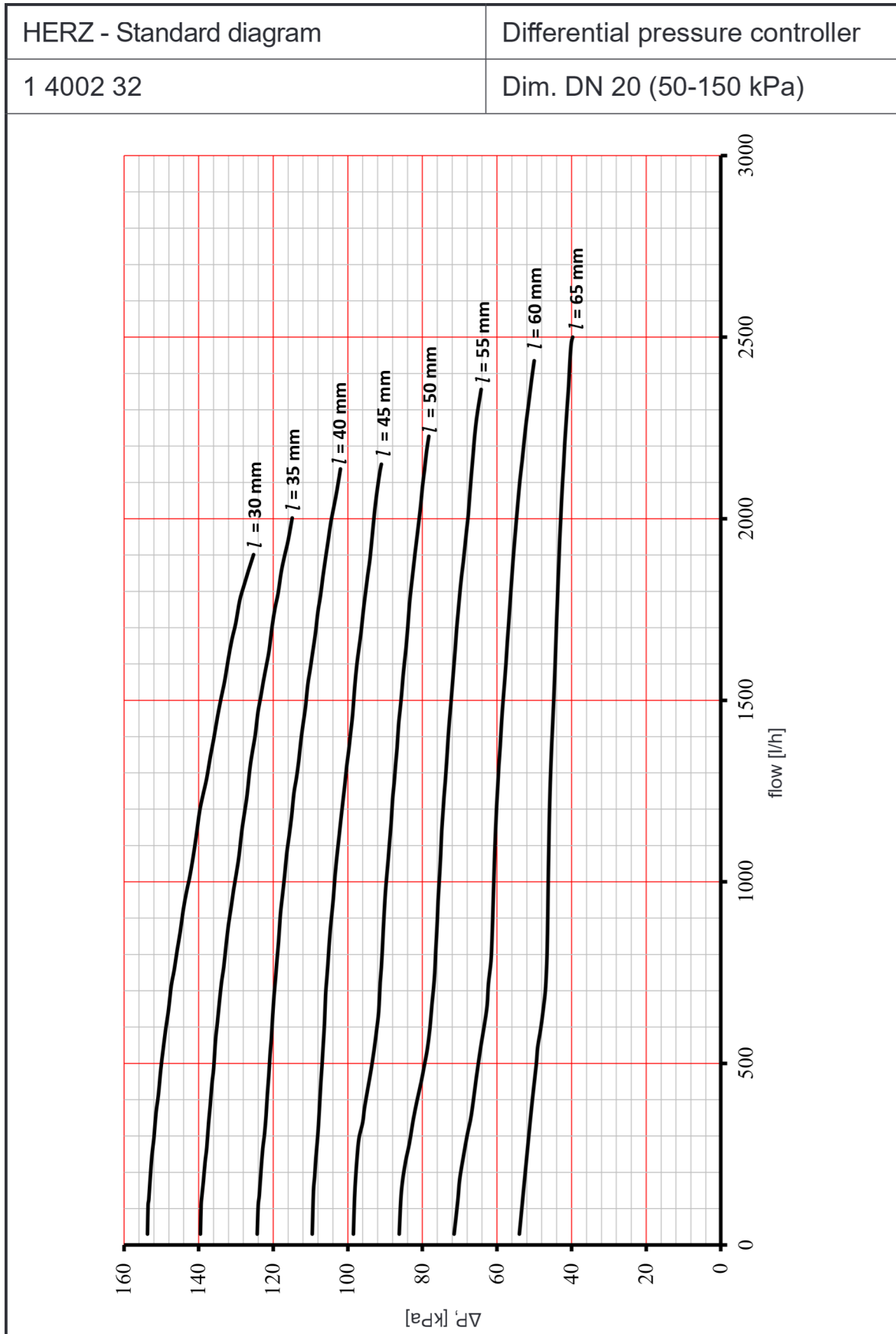

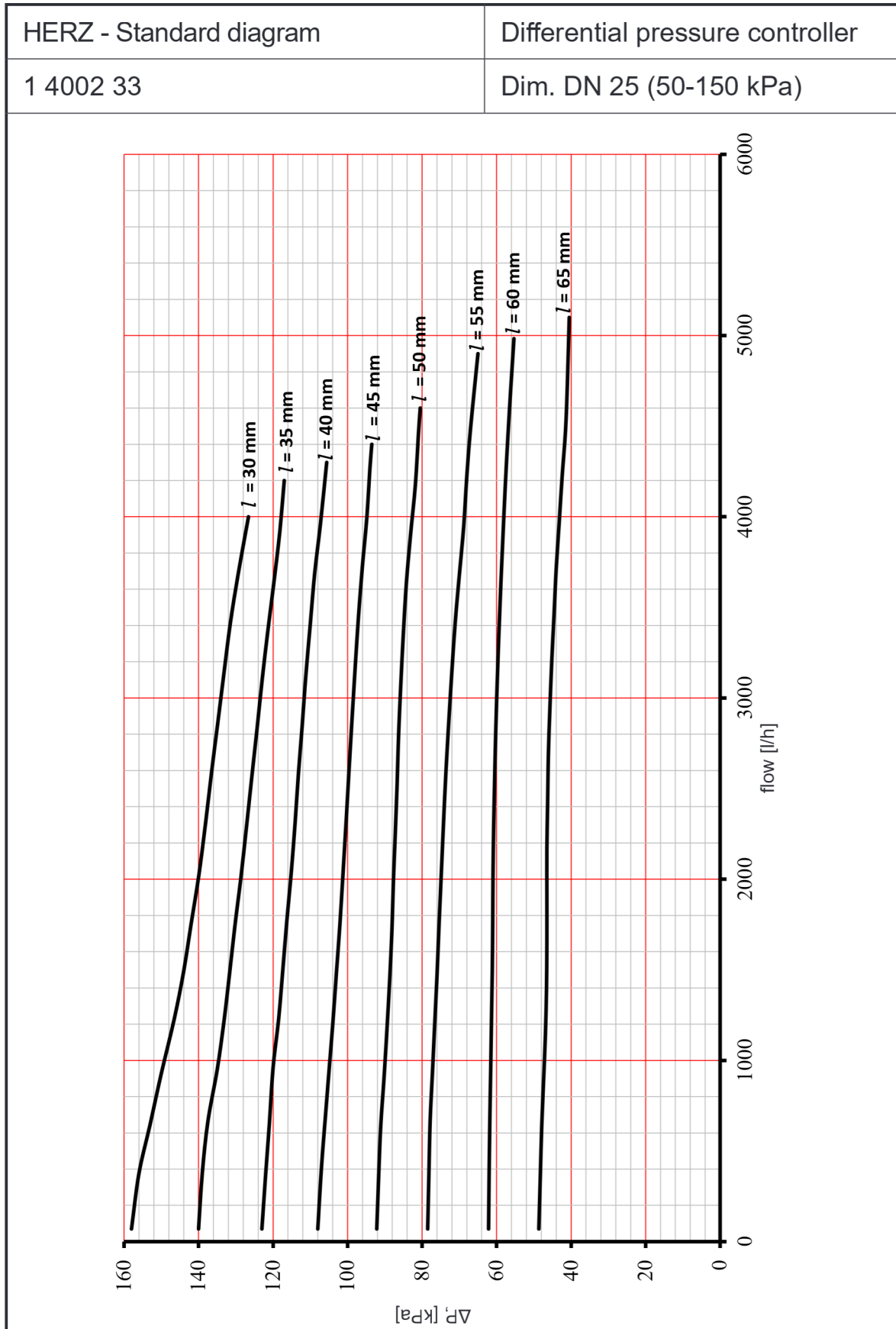

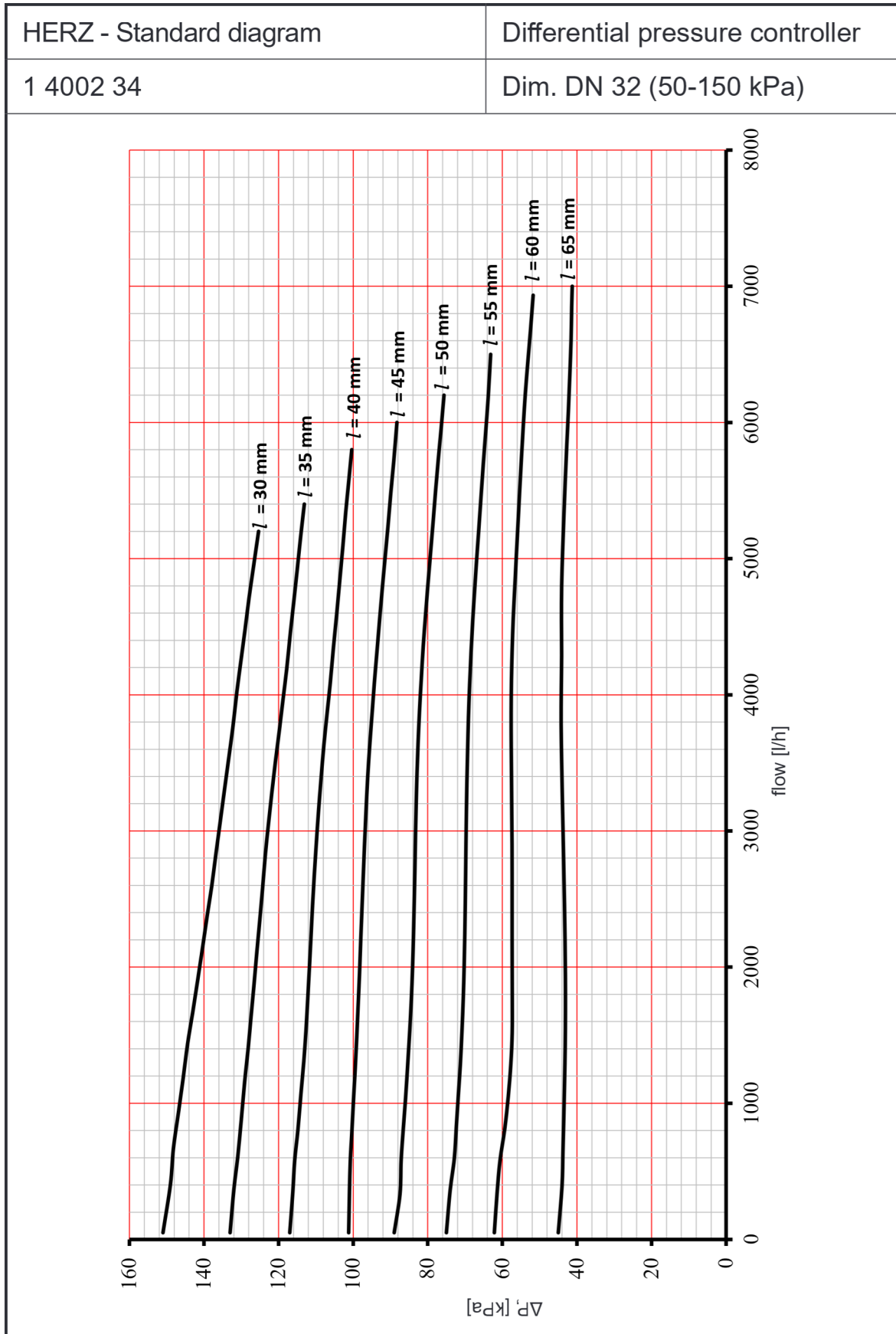

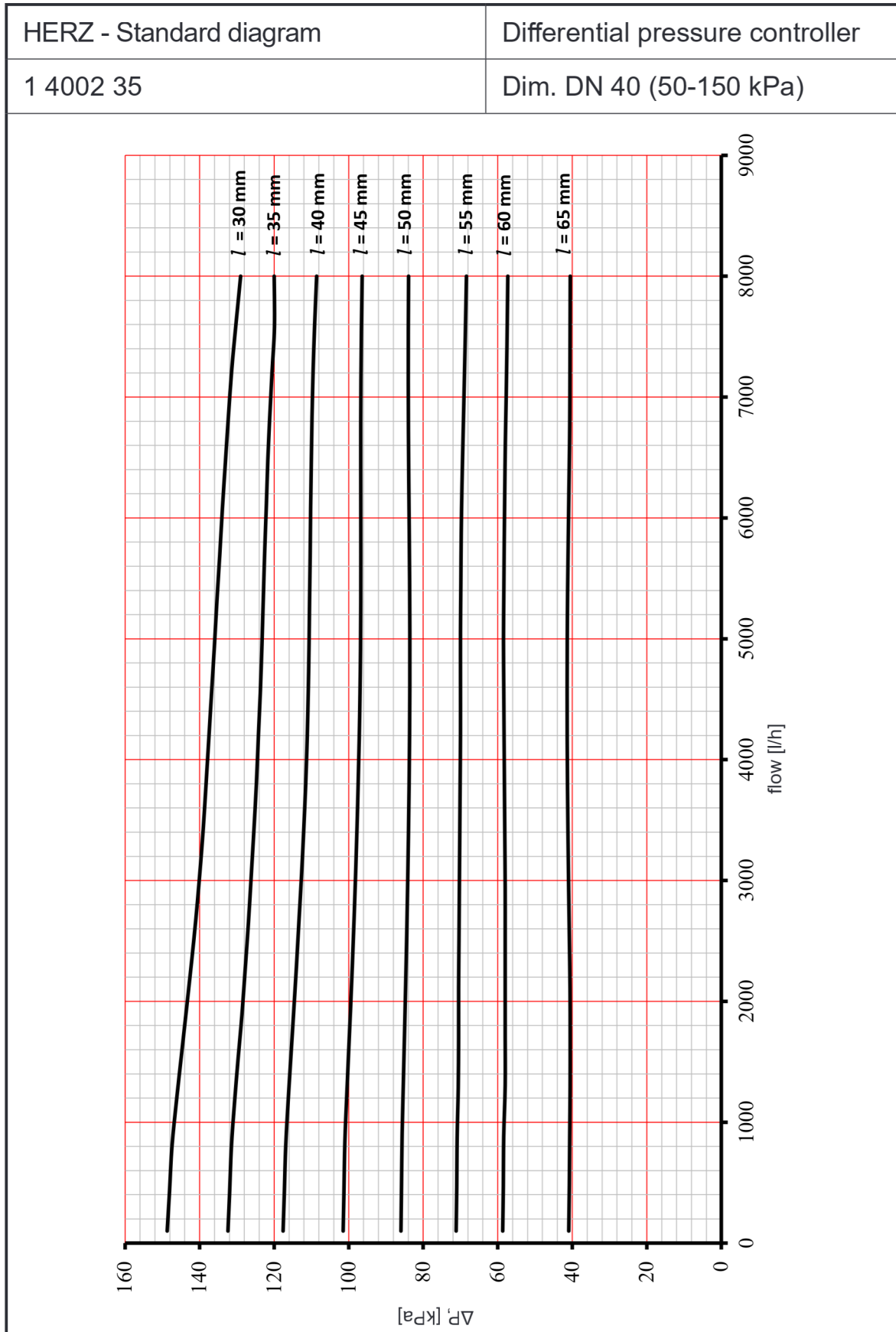

HERZ Differential pressure controller with fixed setpoint

Data sheet 1 4X02 XX (FIX)

Dimensions in mm

1 4002 XX

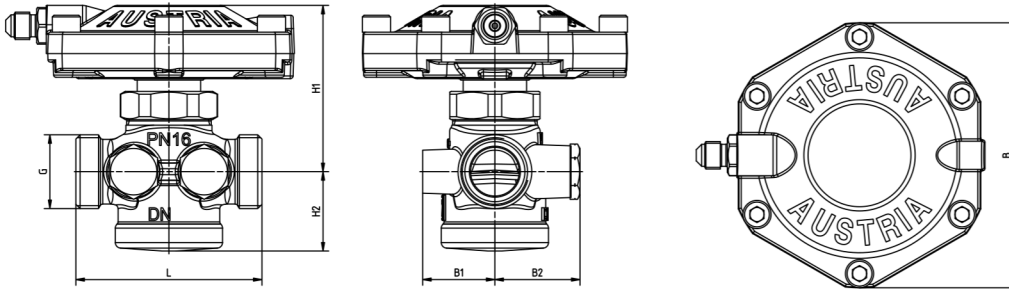

1 4202 XX

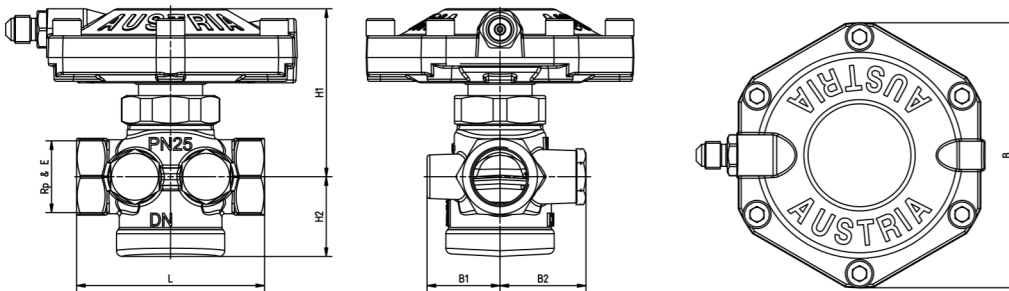

FIX dP	DN	Item		Thread, in	L, mm	H1, mm	H2, mm	B, mm	B1, mm	B2, mm
23 kPa	DN15	1 4002 21	MT	3/4 G	66	59	28	94	26	31
	DN20	1 4002 22		1 G	76	60	29	94	28	33
	DN25	1 4002 23		5/4 flat sealing	76	60	29	94	28	33
	DN32	1 4002 24		1 1/2 flat sealing	114	76	47	94	32	32
	DN40	1 4002 25		1 3/4 flat sealing	132	86	58	94	41	41
	DN50	1 4002 26		2 3/8 flat sealing	140	86	58	94	41	41
23 kPa	DN15	1 4202 21	FT	1/2	66	59	28	94	26	31
	DN20	1 4202 22		3/4	76	60	29	94	28	33
	DN25	1 4202 23		1	90	60	29	94	28	33
	DN32	1 4202 24		5/4	114	76	46	94	32	32
	DN40	1 4202 25		1 1/2	132	86	57	94	41	41
	DN50	1 4202 26		2	140	86	57	94	41	41
50 kPa	DN15	1 4002 59	MT	3/4 flat sealing	66	59	28	94	26	31
13 kPa	DN15	1 4012 01	MT	3/4 flat sealing	66	59	28	94	26	31
13 kPa	DN15	1 4202 01	FT	1/2	66	59	28	94	26	31

Technical data

	DN15	DN20	DN25	DN32	DN40	DN50
k_{VS} value	2,66	4,36	5,38	9,48	14,95	14,95
Operating pressure	max. 16 bar (4002) max. 25 bar (4202)					
Max. differential pressure on the body	4 bar					
Min. operating temperature	2 °C (pure water); - 20 °C (frost protection)					
Max. permissible operating temperature	up to DN32: 130 °C DN40 - DN50: 110 °C					
Control set (see table above)	FIX 23 kPa FIX 50 kPa FIX 13 kPa					
Water quality	according to ÖNORM H 5195 and VDI 2035 The use of ethylene glycol and propylene glycol is permitted in a mixing ratio of 25 - 50% by volume.					

Materials

N	Description	Material
1	O-Rings	EPDM
2	Membrane body	Brass CW602N
3	Membrane	EPDM
4	Compression spring	Spring steel, rust and acid resistant
5	Valve stem	stainless steel 14301
6	Connection nipple	Brass CW602N
7	Connection nut	Brass CW614N
8	Body	DZR brass CC770S

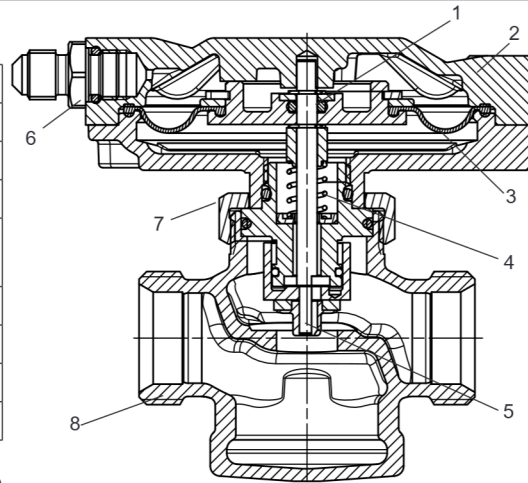

Ammonia contained in hemp damages brass valve bodies, EPDM seals are swollen by mineral oils or lubricants containing mineral oils and thus lead to failure of the EPDM seals. For antifreeze and corrosion protection agents based on ethylene and propylene glycol, the relevant information can be found in the manufacturer's documentation.

Pursuant to Article 33 of the REACH Regulation (EC No. 1907/2006), we are obliged to point out that the material lead is listed on the SVHC list and that all brass components manufactured in our products exceed 0.1% (w/w) lead (CAS: 7439-92-1 / EINECS: 231-100-4). Since lead is a component part of an alloy, actual exposure is not expected and therefore no additional information on safe use is necessary.

Field of application

The Differential pressure controller is a straight-version linear controller and works without auxiliary power. The fixed nominal differential pressure is 23 kPa or 50 kPa. A capillary (1000 mm) is included and should be connected to the regulating valve in the flow.

Installation

The valve is fitted in the return in any position. The arrow on the valve body should align with the direction of flow. It is recommended that an isolation valve is fitted both upstream and downstream of the differential pressure controller.

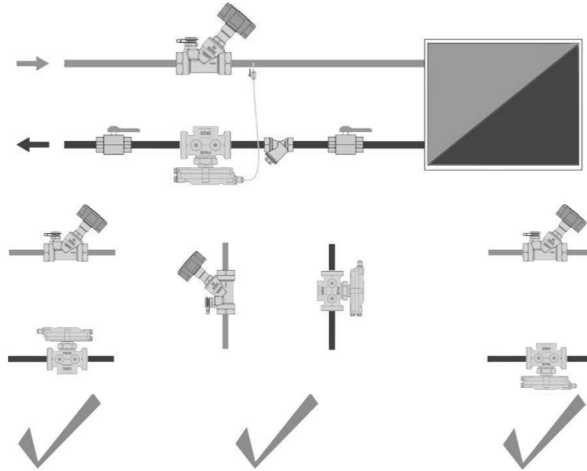

☑ **Warning notices**



The valves must be installed for the correct application using clean fittings. A HERZ strainer (4111) should be fitted to prevent impurities.

☑ **Test points**

Two test points are fitted next to each other. This arrangement ensures the best accessibility and optimal connection of measuring devices in all installation positions.

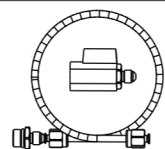
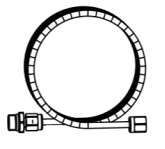
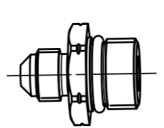
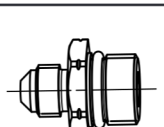
☑ **Accessories and spare parts**

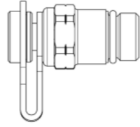
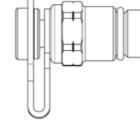
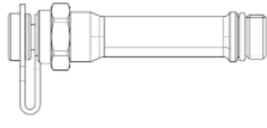
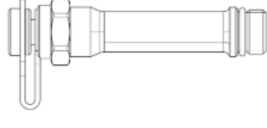
Item	Dim.	Description	Image
1 4002 78	1,0 m	Capillary for differential pressure controller with ball valve 1/8".	
1 4002 80	2,0 m	Capillary for differential pressure controller with connection nipple 1/8" G x 1/4" G.	
1 0269 19	1/8" x 1/4"	Connection nipple for capillary	
1 0269 09	1/8" x 1/8"	Connection nipple for capillary	

1 0284 01	1/4"	Test point for HERZ regulating valve, blue cap (return)	
1 0284 02	1/4"	Test point for HERZ regulating valve, red cap (supply)	
1 0284 11	1/4"	Test point for HERZ regulating valve, extended design, blue cap (return)	
1 0284 12	1/4"	Test point for HERZ regulating valve, extended design, red cap (supply)	
1 0284 21	1/4"	HERZ test point with drain valve, blue cap (return)	
1 0284 22	1/4"	HERZ test point with drain valve, red cap (supply)	

HERZ - Standard diagram	Differential pressure controller
1 4X02 FIX, 23kPa	Dim. DN 15 - 25

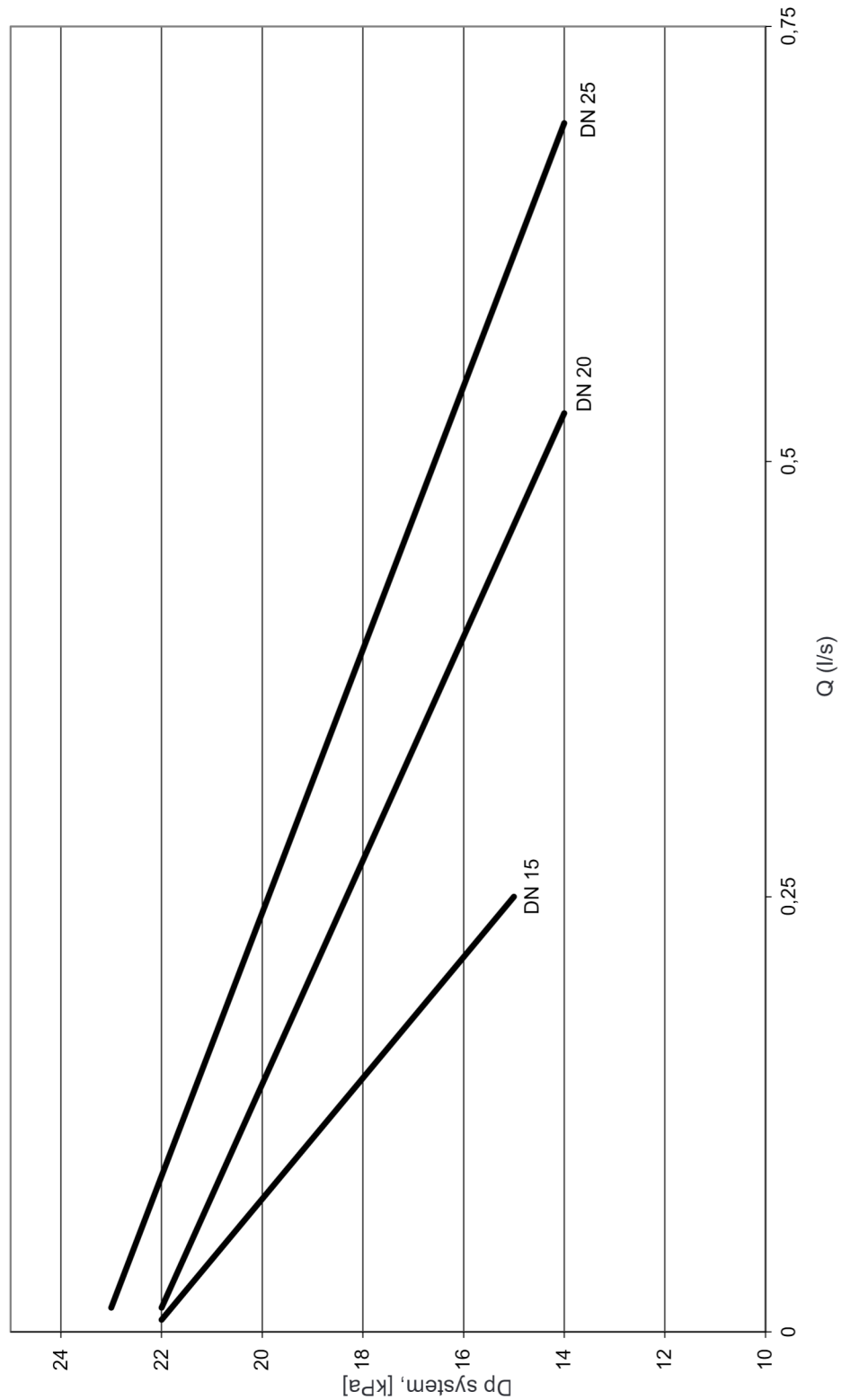

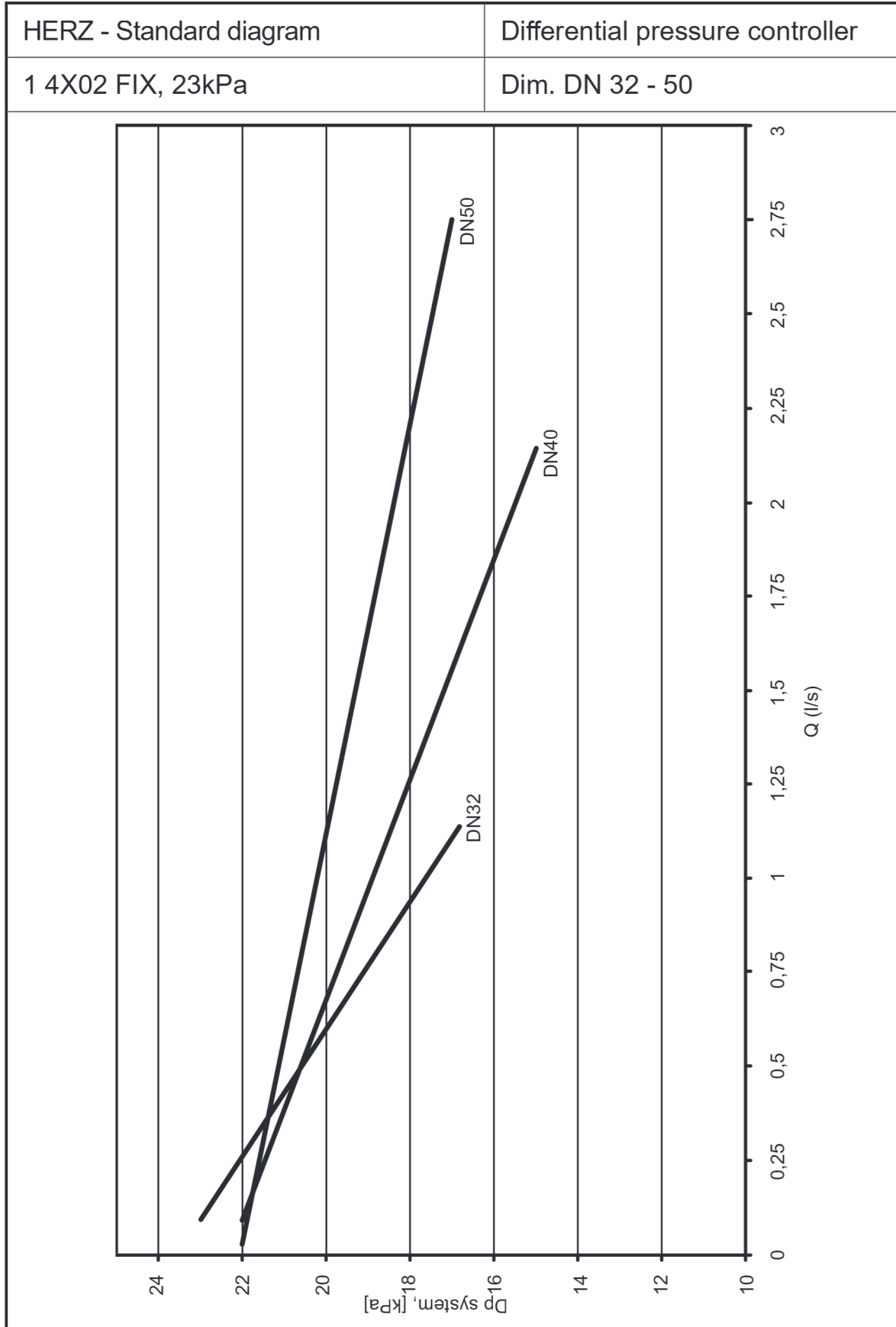

HERZ Differential pressure controller with fixed pressure regulation range and connection thread for drives

Data sheet 1 4X02 XX (FIX TS)

Dimensions in mm

1 4002 XX

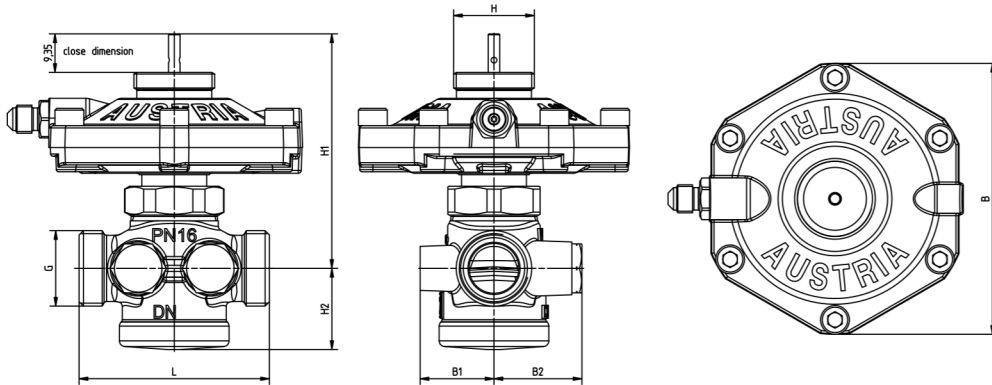

1 4202 XX

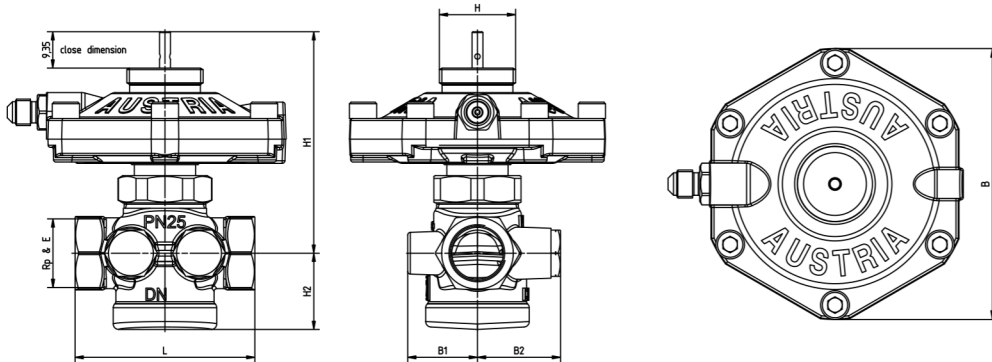

FIX TS [kPa]	DN	Item	Drive	Thread, in	L, mm	H1, mm	H2, mm	B, mm	B1, mm	B2, mm	
23 kPa	DN15	1 4002 81	M28*1,5	MT	3/4 G	66	81	28	94	26	31
	DN20	1 4002 82	M28*1,5		1 G	76	82	29	94	28	33
	DN25	1 4002 83	M28*1,5		5/4 flat sealing	76	82	29	94	28	33
	DN32	1 4002 84	M28*1,5		1 1/2 flat sealing	114	98	47	94	32	32
	DN40	1 4002 85	M28*1,5		1 3/4 flat sealing	132	108	58	94	41	41
	DN50	1 4002 86	M28*1,5		2 3/8 flat sealing	140	108	58	94	41	41
50 kPa	DN15	1 4002 91	M28*1,5	MT	3/4 G	66	81	28	94	26	31
	DN20	1 4002 92	M28*1,5		1 G	76	82	29	94	28	33
	DN25	1 4002 93	M28*1,5		5/4 flat sealing	76	82	29	94	28	33
	DN32	1 4002 94	M28*1,5		1 1/2 flat sealing	114	98	47	94	32	32
	DN40	1 4002 95	M28*1,5		1 3/4 flat sealing	132	108	58	94	41	41
	DN50	1 4002 96	M28*1,5		2 3/8 flat sealing	140	108	58	94	41	41

13 kPa	DN15	1 4002 11	M28*1,5	MT	3/4 G	66	81	28	94	26	31
23 kPa	DN15	1 4202 81	M28*1,5	FT	1/2	66	59	28	94	26	31
	DN20	1 4202 82	M28*1,5		3/4	76	60	29	94	28	33
	DN25	1 4202 83	M28*1,5		1	90	60	29	94	28	33
	DN32	1 4202 84	M28*1,5		5/4	114	76	46	94	32	32
	DN40	1 4202 85	M28*1,5		1 1/2	132	86	57	94	41	41
	DN50	1 4202 86	M28*1,5		2	140	86	57	94	41	41
50 kPa	DN15	1 4202 91	M28*1,5	FT	1/2	66	59	28	94	26	31
	DN20	1 4202 92	M28*1,5		3/4	76	60	29	94	28	33
	DN25	1 4202 93	M28*1,5		1	90	60	29	94	28	33
	DN32	1 4202 94	M28*1,5		5/4	114	76	46	94	32	32
	DN40	1 4202 95	M28*1,5		1 1/2	132	86	57	94	41	41
	DN50	1 4202 96	M28*1,5		2	140	86	57	94	41	41
13 kPa	DN15	1 4202 11	M28*1,5	FT	1/2	66	59	28	94	26	31

Technical data

	DN15	DN20	DN25	DN32	DN40	DN50
k_{vs} value	2,66	4,36	5,38	9,48	14,95	14,95
Operating pressure	max. 16 bar (4002) max. 25 bar (4202)					
Max. differential pressure on the body	4 bar					
Min. operating temperature	2 °C (pure water); - 20 °C (frost protection)					
Max. permissible operating temperature	up to DN32: 130 °C DN40 - DN50: 110 °C					
Control set (see table above)	FIX 23 kPa FIX 50 kPa FIX 13 kPa					
Water quality	according to ÖNORM H 5195 and VDI 2035 The use of ethylene glycol and propylene glycol is permitted in a mixing ratio of 25 - 50% by volume.					

Werkstoffe

N	Description	Material
1	Valve stem	Stainless steel 14301
2	O-Ring	EPDM
3	Membrane body	Brass
4	Membrane	EPDM
5	Compression spring	Spring steel, rust and acid resistant
6	Body	DZR brass
7	Connection nut	Brass
8	Connection nipple	Brass
9	Connection thread for drive	Brass

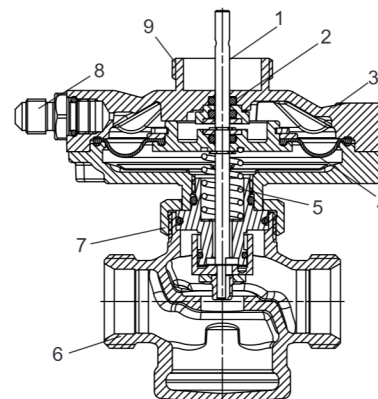

Ammonia contained in hemp damages brass valve housings, EPDM seals are swollen by mineral oils or lubricants containing mineral oil and thus lead to failure of the EPDM seals. For antifreeze and corrosion protection agents based on ethylene and propylene glycol, the relevant information can be found in the manufacturer's documentation.

Pursuant to Article 33 of the REACH Regulation (EC No. 1907/2006), we are obliged to point out that the material lead is listed on the SVHC list and that all brass components manufactured in our products exceed 0.1% (w/w) lead (CAS: 7439-92-1 / EINECS: 231-100-4). Since lead is a component part of an alloy, actual exposure is not expected and therefore no additional information on safe use is necessary.

☑ Field of application

The Differential pressure controller is a straight-version linear controller and works without auxiliary power. The fixed nominal differential pressure is 23 kPa or 50 kPa. A capillary (1000 mm) is included and should be connected to the regulating valve in the flow.

☑ Function description

Automatic HERZ differential pressure controller with integrated zone valve model 4002-FIX-TS and thermal drive.

In two-pipe heating systems, all radiators are equipped with presettable thermostat control valves and thermostat heads (except in the room with room temperature controller). A differential pressure controller with a fixed preset - e.g. 13 kPa - is installed for each apartment or zone with a maximum of 8 radiators. The zone valve integrated in the differential pressure controller is opened or closed as required using a two-point actuator and a programmable room temperature controller. It should be noted that a temperature difference of 2K is selected for the proportional band of the radiator thermostatic valves. In the living room in which the room temperature controller is positioned, the valves should be equipped with a HERZ handwheel (valves always fully open).

Since all differential pressure controllers of the 4002 and 4202 series have a pressure relieved upper part, these automatic zone valves can also be used in risers of systems with district heating and weather-compensated secondary systems. In these cases, however, the factory setting of 23 kPa should be selected. The actuating forces of the thermal drive of 100 N are sufficient in any case.

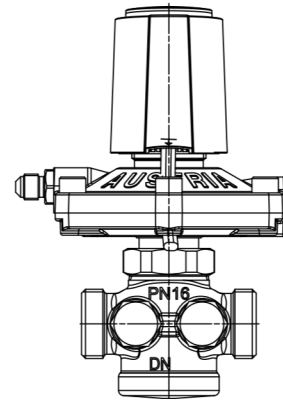

☑ Installation

The valve is fitted in the return in any position. The arrow on the valve body should align with the direction of flow. It is recommended that an isolation valve is fitted both upstream and downstream of the differential pressure controller.

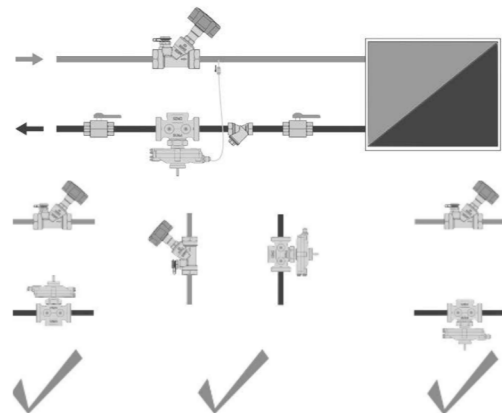





☑ Warning notices

The valves must be installed for the correct application using clean fittings. A HERZ strainer (4111) should be fitted to prevent impurities.

☑ Test points

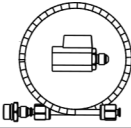
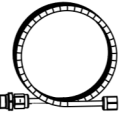
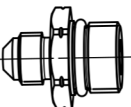
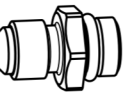
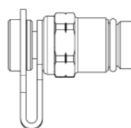
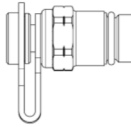
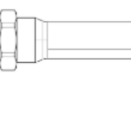
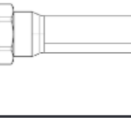
Two test points are fitted next to each other. This arrangement ensures the best accessibility and optimal connection of measuring devices in all installation positions.

Accessories and spare parts

Item	Dim.	Description	Image
1 4002 78	1,0 m	Capillary for differential pressure controller with ball valve 1/8".	
1 4002 80	2,0 m	Capillary for differential pressure controller with connection nipple 1/8"G x 1/4"G.	
1 0269 19	1/8" x 1/4"	Connection nipple for capillary	
1 0269 09	1/8" x 1/8"	Connection nipple for capillary	
1 0284 01	1/4"	Test point for HERZ regulating valve, blue cap (return)	
1 0284 02	1/4"	Test point for HERZ regulating valve, red cap (supply)	
1 0284 11	1/4"	Test point for HERZ regulating valve, extended design, blue cap (return)	
1 0284 12	1/4"	Test point for HERZ regulating valve, extended design, red cap (supply)	
1 0284 21	1/4"	HERZ test point with drain valve, blue cap (return)	
1 0284 22	1/4"	HERZ test point with drain valve, red cap (supply)	
1 7708 52	M28*1,5	HERZ actuating drive for 2-point control, 24 V ~, NC.	
1 7708 53	M28*1,5	HERZ actuating drive for 2-point control, 230 V ~, NC.	

HERZ - Standard diagram	Differential pressure controller
1 4X02 FIX TS, 23kPa	Dim. DN 15-25

