



Ultra 4

Instruction Manual



ULTRA 4 (SECOND EDITION REV 3)

August 2021

Part Number M-174-1-002-3P

COPYRIGHT

© Pulsar Measurement, 2020 -21. All rights reserved. No part of this publication may be reproduced, transmitted, transcribed, stored in a retrieval system, or translated into any language in any form without the written permission of Pulsar Measurement.

WARRANTY AND LIABILITY

Pulsar Measurement guarantee for a period of 2 years from the date of delivery that it will either exchange or repair any part of this product returned to Pulsar Measurement if it is found to be defective in material or workmanship, subject to the defect not being due to unfair wear and tear, misuse, modification or alteration, accident, misapplication, or negligence.

DISCLAIMER

Pulsar Measurement neither gives nor implies any process guarantee for this product and shall have no liability in respect of any loss, injury or damage whatsoever arising out of the application or use of any product or circuit described herein.

Every effort has been made to ensure accuracy of this documentation, but Pulsar Measurement cannot be held liable for any errors.

Pulsar Measurement operates a policy of constant development and improvement and reserves the right to amend technical details, as necessary.

The Ultra 4 shown on the cover of this manual is used for illustrative purposes only and may not be representative of the actual Ultra 4 supplied.

CONTACT

For technical support, please contact:

Europe: supporteurope@pulsarmeasurement.com

Outside Europe: supportnorthamerica@pulsarmeasurement.com

If you have any comments or suggestions about this product, please contact:

Europe: europe@pulsarmeasurement.com

Outside Europe: northamerica@pulsarmeasurement.com

Pulsar Measurement website: www.pulsarmeasurement.com

United States

11451 Belcher Road South
Largo,
FL 33773
888-473-9546

Canada

16456 Sixsmith Drive
Long Sault, Ont.
K0C 1P0
855-300-9151

United Kingdom

Cardinal Building, Enigma
Commercial Centre
Sandy's Road, Malvern
WR14 1JJ
00 44 (0)1684 891371

CONTENTS

Chapter 1: Start Here.....	9
About this Manual	9
About the Ultra 4.....	10
Functional Description	11
How to use this Manual.....	12
Product Specification.....	13
EU Certificate of Conformity.....	15
Chapter 2 Ultra 4 Installation	16
Unpacking	16
Power Supply Requirements.....	16
Location	16
Typical system wiring.....	18
Dimensions	19
Wall Mount.....	19
Fascia Mount.....	21
Terminal connection details.....	23
Interface Connections	24
Terminal Connections.....	24
Fuse Location.....	26
Preparation for Operation	27
Maintenance	27
Chapter 3 How To Use Your Ultra 4	28
Operating the Controls.....	28
Run Mode.....	29
How to Access Program Mode.....	38
Menu Keys	39
Hot Keys.....	40
Numeric Keys.....	40
Using the Menu System	41
Directly Editing Parameters.....	42
Test Mode	43

Using the Serial Interface	44
Parameter Defaults	46
Chapter 4 Ultra Wizard	47
Enter Program Mode	47
Choose Ultra Wizard	47
Ultra 4 - Level / Volume	48
Ultra 4 - Pump control	48
Ultra 4 - Flow	49
Chapter 5 Level / Volume	51
Quick Setup	53
Example 1 Level Monitoring with Alarms	57
Example 2 Level Monitoring and Control (up or down)	59
Example 3 Volume Application	61
Chapter 6 Pump	64
Quick Setup Menu	66
Example 4 Level Monitoring with Alarms	69
Example 5 Sump Control (pump down)	71
Example 6 Reservoir Control (pump up)	73
Chapter 7 Flow	75
Exponential Devices	82
Calculations	85
BS3680 Flumes (P700 = 2)	89
Rectangular Flume Calculations	90
U-Throated Flume Calculations	91
Example 2 BS3680 U-Throated Flume	92
BS3680 Weirs (P700 = 3)	94
Rectangular Weir Calculations	94
V-Notch Weir Calculations	95
BS3680 Rectangular Broad Crested Weir	98
Rectangular Broad Crested Weir Calculations	99

- Special Devices.....100
- Palmer Bowlus and H-Flume Calculations101
- V-Notch Angle Weir (Non-BS 3680) Calculations.....102
- Universal Calculations (P700=6).....102
- Chapter 8 Parameter Guide103
 - Menu System103
 - Top Level Menu103
 - Application Menu.....104
 - Relays Menu105
 - Data Logs Menu106
 - Volume: Available when Ultra Wizard = Volume.....107
 - OCM: Available when Ultra Wizard = Flow108
 - Display Menu109
 - mA Output Menu110
 - Compensation Menu110
 - Stability Menu111
 - Echo Processing Menu.....112
 - System Menu113
 - Device Comm Menu114
 - Test Menu115
 - Application Parameters.....116
 - Operation116
 - Dimensions117
 - Relay Parameters.....120
 - Alarms.....121
 - General Control.....125
 - Pumps.....126
 - Control.....129
 - Miscellaneous131
 - Common Parameters.....133
 - Data Log parameters133

Volume	138
When Ultra Wizard = 1 Level/Volume	138
Conversion	138
Breakpoints	143
Tables	144
OCM Parameters	145
Dimensions	149
Calculations	153
Breakpoints	154
Tables	154
Average Flow	154
Display Parameters	155
Options	155
Failsafe	156
Auxiliary	157
Totaliser	158
mA Output Parameters	160
Range	160
Operation	161
Setpoint	161
mA Limits	162
mA Trim	163
mA Failsafe	165
Compensation Parameters	165
Offset	165
Temperature	165
Velocity	166
Stability Parameters	167
Damping	167
Rate	167

Filters.....	168
Echo Processing Parameters.....	169
Transducer Status.....	169
System Parameters.....	170
Passcode.....	170
Backup.....	170
Params ↔ SD.....	171
System Information.....	171
Date & Time.....	172
Watchdog.....	172
Daylight Saving Time.....	173
Service Alarm.....	176
Language.....	177
Device Comm.	178
RS232 Set Up.....	178
Modbus.....	178
Profibus.....	180
HART.....	181
Test Parameters.....	183
Simulation.....	183
Hardware.....	184
Chapter 9 SD Card Logger.....	186
About the Micro SD card logger.....	186
Types of Files.....	186
Setting up the unit to log.....	187
Chapter 10 Troubleshooting.....	188
Chapter 11 Disposal.....	189

CHAPTER 1: START HERE...

Congratulations on your purchase of a Pulsar Ultra 4. This quality system has been developed over many years and represents the latest in high technology level measurement and control.

It has been designed to give you years of trouble-free performance, and a few minutes spent reading this operating manual will ensure that your installation is as simple as possible.

About this Manual

It is important that this manual is referred to for correct installation and operation. There are various parts of the manual that offer additional help or information as shown.

Tips



TIP: Look for this icon throughout your Pulsar Measurement manual to find helpful information and answers to frequently asked questions.

Additional Information

Additional Information

At various parts of the manual, you will find sections like this that explain specific things in more detail.

About the Ultra 4

Ultra 4 is a brand-new concept in ultrasonic level measurement. Within its memory are all the functions and settings of three different and separate ultrasonic devices.



The Ultra 4 does not offer a multiple range of functions blended together which leads to complicated calibration and a compromise to the specification. The Ultra 4 is the first ever system to offer the ability to dedicate the functionality of the unit to any of three specific duties i.e., level or volume measurement, pump control, or flow measurement. Diagnostic trace information and measurement trending can be viewed directly on the display of the unit itself and automatically logged to SD card.

The benefits are many but most importantly the unit provides:

1. A most versatile system which can be configured quickly, to offer one of three separate functions within a matter of seconds. Ideal for simplicity of purchase and off the shelf spares.
2. Ability to log vast amounts of data using the integral Micro SD card slot, and at a minimum of 1-minute intervals.
3. A totally dedicated device with the ability to perform all aspects of the task required i.e., no compromise in specification.
4. Easy to set up using Pulsars unique "Quick Set Up" Menu. To calibrate the unit, first set the Ultra Wizard for the desired task, then refer to the relevant chapter in this manual that relates to your application:

Chapter 5 for **Level** or **Volume**,

Chapter 6 for **Pump Control**

Chapter 7 for **Flow**

Functional Description

Ultra 4 sends a transmit pulse to the transducer, which emits an ultrasonic pulse or radar signal (dependent on transducer) perpendicular to the transducer face, and the returned echo is sent back to the Ultra 4. The time taken to receive the echo is measured and the distance from the transducer face to the surface being monitored is calculated.

Ultra 4 can measure from zero to 40m from the face of the transducer to the surface being monitored, dependent on the application chosen and transducer used.

The relays can be programmed to activate alarms, pump starters, or other control equipment. There is an isolated 4-20 mA output that can be connected to a recorder or PLC, to monitor, depending on application chosen, **level, space, distance, OCM head, OCM flow or volume**, independently from that shown on the display. There is an RS232 port, so that the Ultra 4 can be operated remotely by a PC or other equipment.

Ultra 4 can be programmed either by the built-in keypad (standard on all wall and fascia units), via the SD card slot or by PC via the RJ11 Serial Interface. All parameters are stored in a non-volatile memory, so are retained in the event of power interruption. A second backup copy of all parameters can also be retained in the Ultra 4 memory, in case an alternative set of parameters needs to be stored.

Four user definable relays with individual setpoints and intelligent performance logging software features ensure maximum control versatility.

The system utilises the unique DATEM software (**D**igital **A**daptive **T**racking of **E**cho **M**ovement). This is a proven digital mapping technique developed especially for the Pulsar **Ultra** range, which gives the system unequalled ability when identifying the "true target level" in the face of competing echoes from pipes, pumps, or other obstructions. Coupled with the powerful, long-range abilities of the 'all new' dB transducer range, the Ultra 4 lives up to its reputation as the most reliable ultrasonic level measurement system available.

The Pulsar Ultra 4 ultrasonic level controllers have been designed to provide maintenance-free fit and forget performance.

How to use this Manual

1. Read the **installation** and **operating** instructions contained in, **Chapters 2** and **3**, carefully, they are applicable in every use of this product.
2. Decide which “task” you wish your Ultra 4 to perform for you and then configure the unit using “**Ultra Wizard**” as described in **Chapter 4**.
3. Move directly to the appropriate chapter of this manual, as listed below, for details on how to program Ultra 4 using the “Quick Set Up” Menu.
4. Alternatively, if you are familiar with Pulsar products or you wish to directly program your unit, please refer to **Chapter 8 Parameter descriptions**.

CHAPTER	DUTY / TASK
Chapter 5 Level/Volume	Measurement of Level or Volume
Chapter 6 Pump	Control of Pumps
Chapter 7 Flow	Measurement of Open Channel Flow

Product Specification

PHYSICAL

Wall Mount outside Dimensions	150 x 130 x 64mm (5.9 x 5.1 x 2.5")
Weight	Nominal 700g
Enclosure Material/Description	Polycarbonate flame resistant to UL94-5V
Cable entry detail	3 x M20 cable glands, for cable dia. 5 to 13mm (0.2" to 0.5")
Fascia Mount outside dimensions	160 x 180 x 64mm (6.3 x 7.1 x 2.5")
Weight	1.3kg
Enclosure material/description	Polycarbonate flame resistant to UL94-5V
Transducer Cable Extensions	2-core screened (minimum)
Maximum Separation	1000m (3,280 ft), 500m (1,640 ft) for mmWave

ENVIRONMENTAL

IP Rating (Wall)	IP67 / NEMA 4X
IP Rating (Fascia)	IP64
Max. & min. temperature (electronics)	-20°C to +45°C (-4°F to +113°F)
Flammable atmosphere approval	Safe area: compatible with approved transducers and sensors. (see spec. sheets)
CE Approval	See EU Declaration of Conformity
UL Approval	UL61010-1

PERFORMANCE

Accuracy	0.25% of the measured range or 6 mm (whichever is greater). ± 2mm for mmWAVE RADAR
Resolution	0.1% of the measured range or 2 mm (whichever is greater)
Max. Range	Dependant on transducer (maximum 40m dB40)
Min. Range	Dependent upon application and transducer (minimum zero dB Mach3)
Rate Response	Fully adjustable

ECHO PROCESSING

Description	DATM (Digital Adaptive Tracking of Echo Movement)
Technology	Ultrasonic and MCW Radar

OUTPUTS

Analogue I/O	Isolated (floating) output (to 150V) of 4-20 mA or 0-20 mA into 1K Ω (user programmable and adjustable)
Digital output	Full Duplex RS232
Volt free contacts, number, and rating	3 x SPCO isolated relays, rated at 5A at 250V AC and 1 solid state SPNO isolated relay, rated 30V at 100mA (to suit pulse counter applications).
Display	Monochrome graphical dot-matrix, 160 x 240 pixels. Fully programmable display options with integral keypad and menu navigation keys.

PROGRAMMING

On-board programming	By integral keypad
PC programming	Via RJ11 port on unit, or via Micro SD
Programming security	Via passcode (user selectable and adjustable)
Programmed data integrity	Via non-volatile RAM, plus backup
Data logging and removable storage	Via micro-SD card slot and internal 10-day totaliser logs (flow only).
SD card memory (included)	16GB

SUPPLY

Power Supply	115VAC +5% / -10% 50/60 Hz, 230VAC + 5% / -10% 50/60 Hz, dc 18 - 30V 10W maximum power (typically 6W)
Fuse, mains	100mA at 230V AC (fitted as standard to wall units) 200mA at 115V AC (fitted as standard to fascia units)
Fuse, transducer	100mA barrier type, 4000A breaking

COMMUNICATIONS (OPTIONAL)

Modbus RTU/ASCII	Isolated RS485
Profibus DPV1	Isolated RS485
HART 7	Isolated 4-20mA
DNP3/WITS	Gateway interface (pending)

Pulsar Measurement operates a policy of constant development and improvement and reserve the right to amend technical details, as necessary.

EU Certificate of Conformity**EU DECLARATION OF CONFORMITY****PULSAR *Ultra controllers range***

This declaration of conformity is issued under the sole responsibility of the manufacturer

Relevant directive(s)	2014/30/EU - EMC directive and its amending directives. 2014/35/EU - Low Voltage directive and its amending directives. 2011/65/EU - RoHS directive and its amending directives.
Manufacturer's name	Pulsar Process Measurement Ltd.
Manufacturer's address	Cardinal Building, Enigma Business Commercial Centre, Sandy's Road, Malvern, Worcestershire, WR14 1JJ, UK.
Apparatus	System controller with optional communications.
Models	Pulsar Ultra wall mount, including Ultra 3, Ultra 5, Advanced rake master 2.2, Oracle CSO 2.1, Ultra 3 i.s. . Pulsar Ultra Fascia mount including Ultra 3, Ultra 5, Quantum, Zenith. Pulsar Ultra 4, wall & fascia mount. Ultra Lite, wall & fascia mount. Pulsar Ultra rack mount. Pulsar Ultra Twin, wall & fascia mount.
Type of equipment	Measurement and process control.
Standards applied	EN 61010-1:2010+A1:2019 Safety requirements for electrical equipment for measurement, control and laboratory use. EN 61326-1:2013 EMC, equipment class industrial.

I declare that the apparatus named above has been tested and complies with the relevant sections of the above referenced standards & directives.

Signed for and on behalf of:

A handwritten signature in black ink, appearing to read "Tim Brown".

Date: 7th April 2021.

Rev. 5.0 .

Name & function:

Tim Brown, electronics engineer.

Pulsar Process Measurement Ltd.

CHAPTER 2 ULTRA 4 INSTALLATION

Unpacking

Important Information

All shipping cartons should be opened carefully. When using a box cutter, do not plunge the blade deeply into the box, as it could potentially cut or scratch equipment components. Carefully remove equipment from each carton, checking it against the packing list before discarding any packing material. If there is any shortage or obvious shipping damage to the equipment, report it immediately to your local Pulsar distributor.

Power Supply Requirements

Ultra 4 can operate from AC supply or from a DC supply or battery. The rated **AC** range is between **100V and 240V 50/60Hz**. The **DC** range is **10 – 28V**. In both cases the Ultra 4 will typically consume 6W of power, with a maximum of 10W.

Location

When choosing a location to mount the enclosure, please bear in mind the following:

- Ensure that the Ultra 4 is installed in a "Safe", non-hazardous, area.
- For a clear view of the display, it is recommended that it is mounted at eye level.
- The mounting surface is vibration-free.
- The ambient temperature is between -20°C and 45°C (-4°F and 113°F).
- When installing the fascia, remember the temperature within an equipment cabinet may be higher than the outside ambient, depending on the heat generated within and ventilation provided.
- There should be no high voltage cables or inverters close by.
- There should not be any heat-generating components nearby.

All electronic products are susceptible to electrostatic shock, so follow proper grounding procedures during installation.

When forming part of a system used in a hazardous area, the Ultra 4 must be mounted in a non-hazardous (safe) area, and the transducer / sensor fitted in the hazardous area.

Appropriate safety precautions must be taken (IECEx / ATEX / FM).

Exia (I.S.) installations require a safety barrier and protective earth.

Exmb installations require protected cable runs and adequate fusing.

Refer to local regulations and standards for specific requirements.

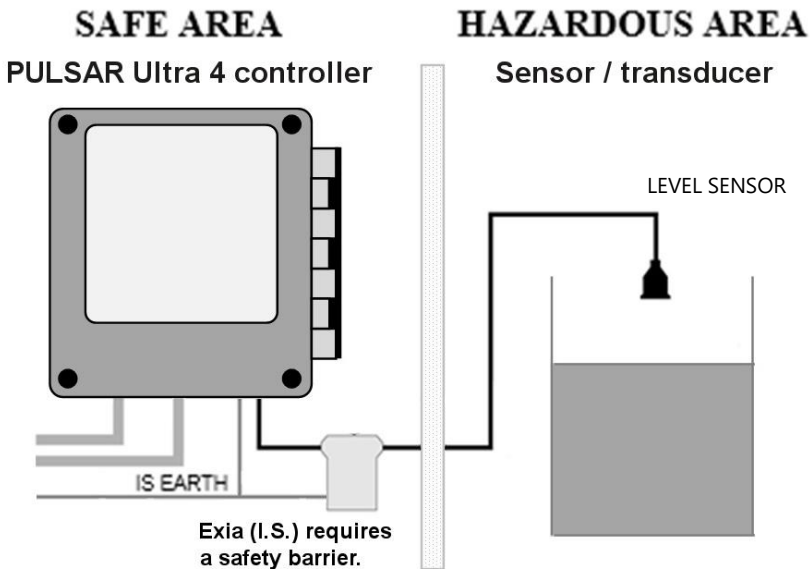

Important Information

All electronic products are susceptible to electrostatic shock, so follow proper grounding procedures during installation.

Typical system wiring

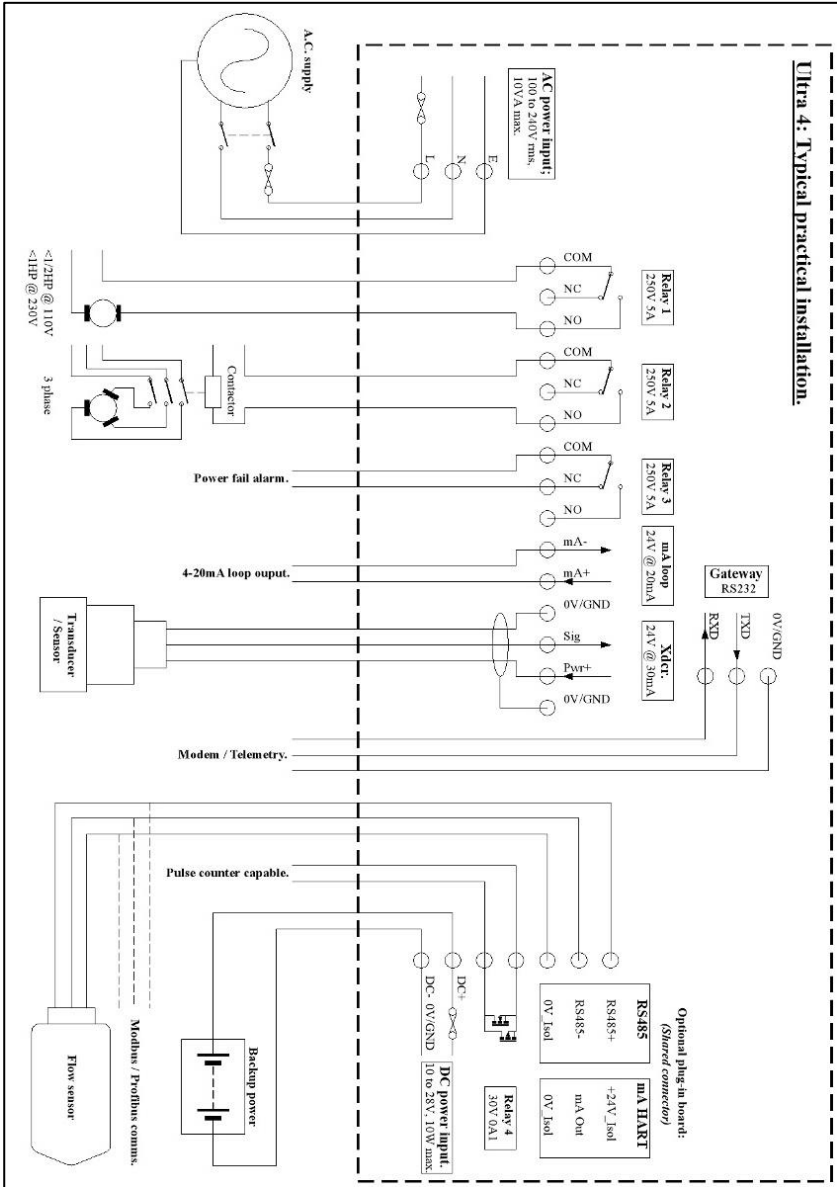

Dimensions

Wall Mount

The dimensions of the wall fixing holes are as shown below:

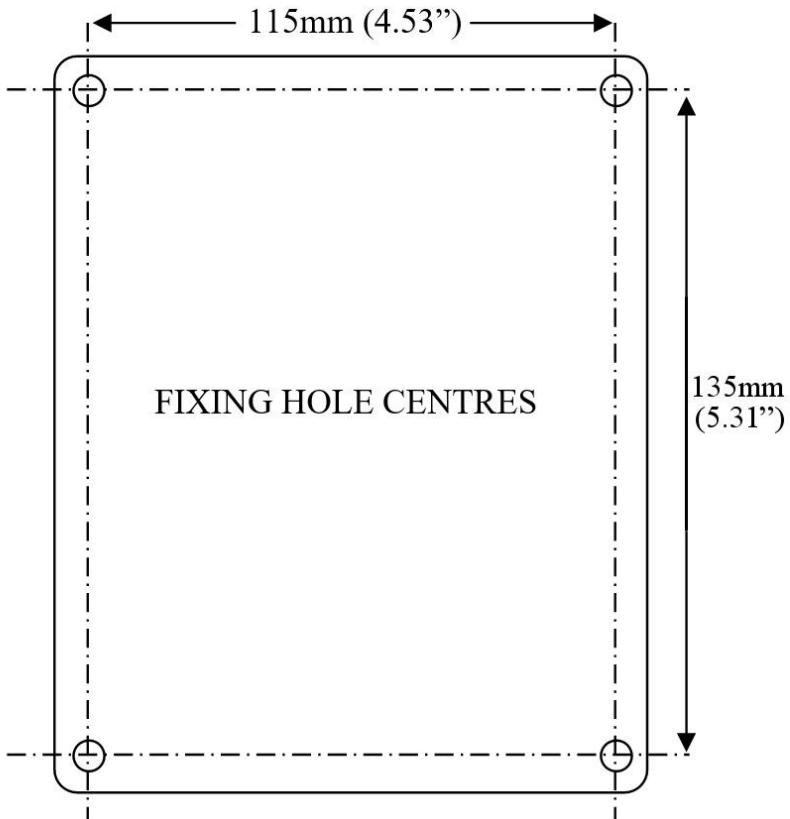

Ultra 4 (wall-mount) should be mounted by drilling four holes suitable for size 8 self-tapping screws (length to suit your application).

Where machine screws are required, M3.5 is the best size to use.

The full dimensions of the wall-mount enclosure are shown below:

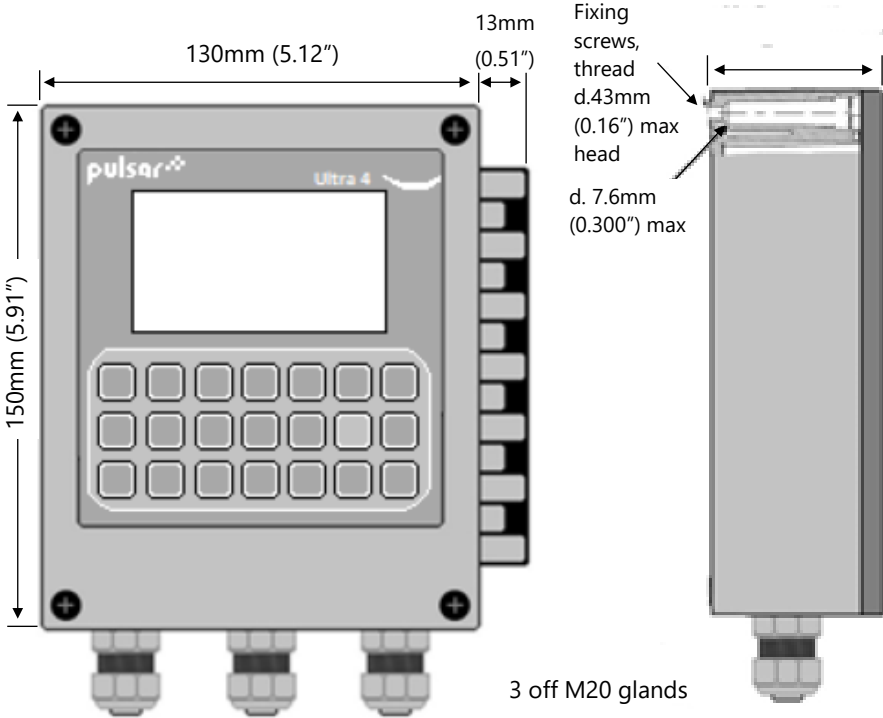

Cable Entry

Three M20 cable glands are supplied fitted. They accept cables between 5.0 and 13.0mm (0.2" to 0.5") overall diameter. The gland cable nuts require a 24mm A/F spanner; tighten to a torque of 2Nm.

Fascia Mount

The Fascia mount Ultra 4 should be installed by cutting a rectangular hole and four fixing holes in the panel as detailed below. Observe minimum clearances to the cabinet and other equipment as shown.

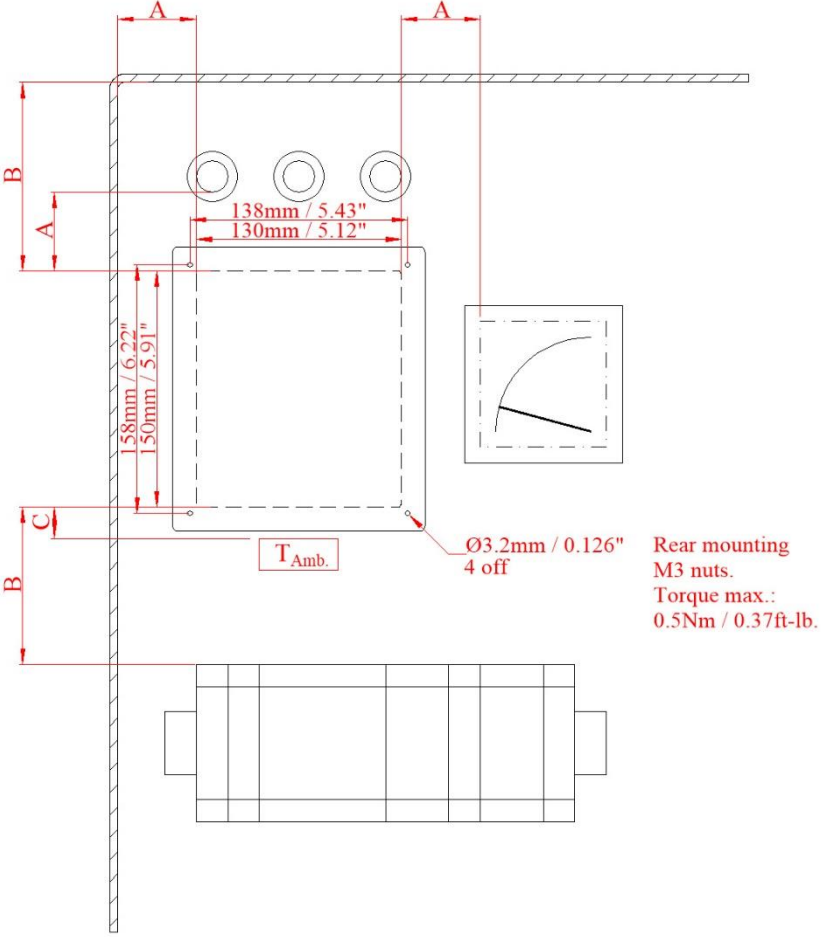

- A: Clearance at sides or to small parts above or below. > 50mm / 2"
- B: Clearance at top or bottom to cabinet or large parts. > 100mm / 4"
- C: Position for ambient temperature measurement. 25mm / 1"

The full dimensions of the fascia enclosure are shown below:

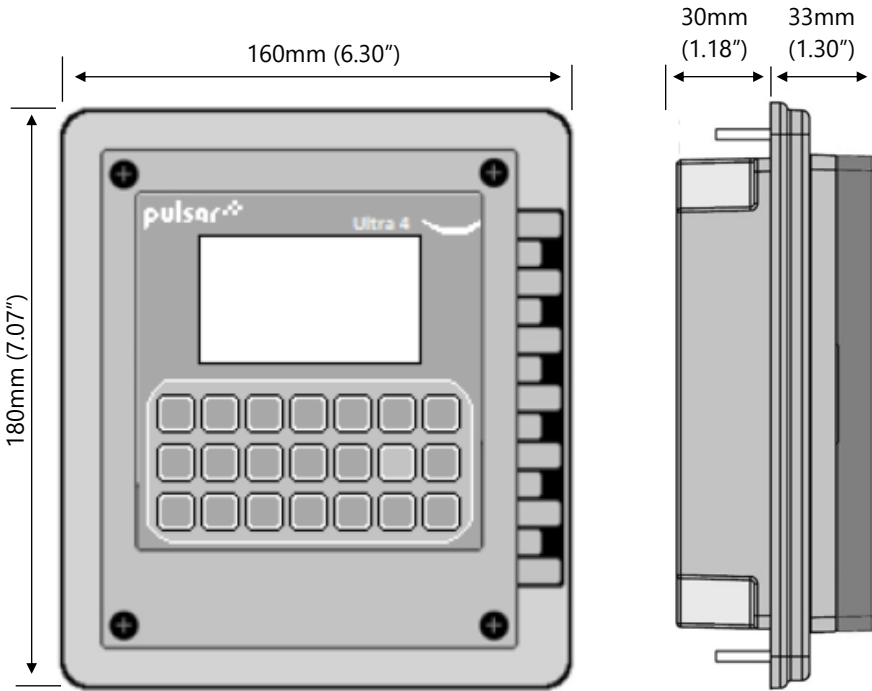

There is a sealing gasket that sits under the flange; check that this is installed and is a flat fit against the panel. The mounting nuts are M3, requiring a 5.5mm A/F socket. They should be tightened to a torque of 0.5Nm.

Terminal connection details

Wall Mount

The terminal strip is as detailed below:

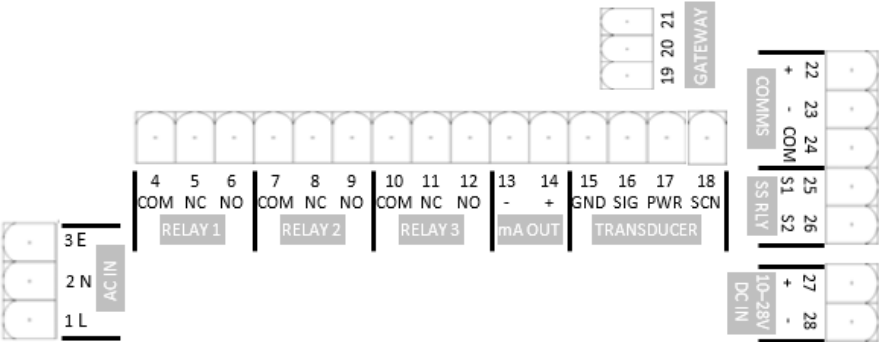

Fascia Mount

The terminal details are as illustrated below:

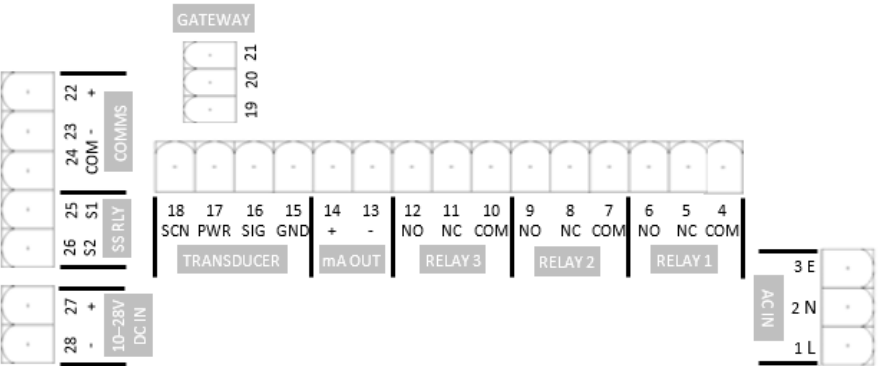

Interface Connections

The SD card slot labelled 'SD', and the RJ11 socket labelled 'PC' are situated on the LCD display board as detailed below:

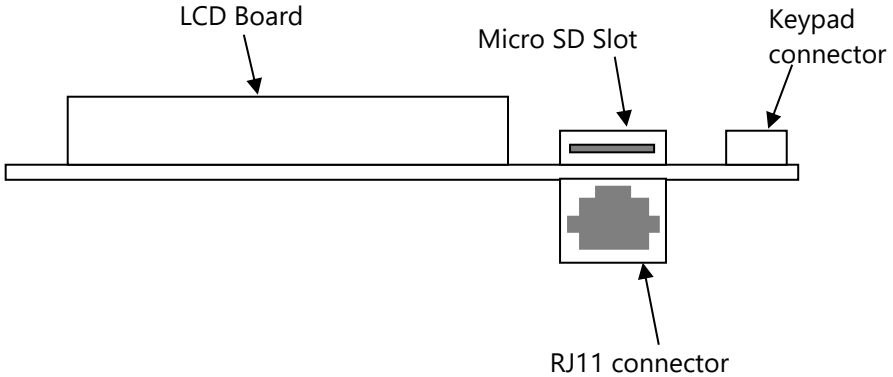

Terminal Connections

Power

Ultra 4 can operate from mains AC and automatically from DC or battery backup in the event of a power failure or can be operated permanently from DC or batteries.

Transducer/sensor

The transducer should be installed, and connected, in accordance with the installation instructions contained in the Transducer User Guide.

The entire range of, standard dB transducers and mmWave dBR sensors are certified for use in hazardous areas. See the product label for certification details. Wire the transducer to the Ultra 4's transducer terminals, as follows:

TERMINAL CONNECTION DETAILS

Black: 0Volts	White: Signal	Red: Power	Green: Screen
15	16	17	18

When using 2-core screened extension cable, the Black and Green wires of the transducer should be connected to the screen of the extension cable which in turn should be connected to the appropriate 0 volts' terminal of the Ultra 4.

Relay Outputs

All four of the relays can be programmed for a variety of alarms, pump control, or other process functions. Three relays have contacts rated at 5A at 240V AC. The fourth is a low power solid state SPNO isolated relay, intended to be suitable for pulse counter functions.

All connections should be fused or protected such that the short circuit capacity of the circuits to which they are connected is limited so that they do not exceed the relay rating.

Current Output

This is an isolated (floating) mA output (to 150 V), of 4 - 20mA or 0 - 20mA, and the load should not exceed 500 Ω .

RS2323 Serial Interface

If required, you can connect to the serial interface to operate your Ultra 4 remotely.

Wire/cable ratings & sizes (Copper conductors)

CONNECTOR	RATING	WIRE SIZE (MIN)	WIRE SIZE (MAX)	
Power, AC	120V / 240V 2A min	0.5mm ² /20 AWG	2.5mm ² / 12 AWG	
Power, DC	30V 2A min.	0.5mm ² /20 AWG		
Relays 1-3	For max. rated 5A rms use 1mm ² / 18AWG min.	Depends on load.		
Relay 4, SSR	30V 0A2 min.	0.2mm ² /30 AWG		
Transducer	30V 0A2 min. Pulsar cable is 0.5mm ² / 20AWG.	0.2mm ² / 30AWG.		
mA out	30V 0A2 min	Depends on distance.		
Comms.	150V 0A2 min.	0.2mm ² / 30AWG		
Gateway RS232	30V 0A2 min	0.2mm ² / 30AWG		1.5mm ² / 12 AWG

Fuse Location

The mains fuse is located inside the terminal compartment, under the removable protective cover, as shown below:

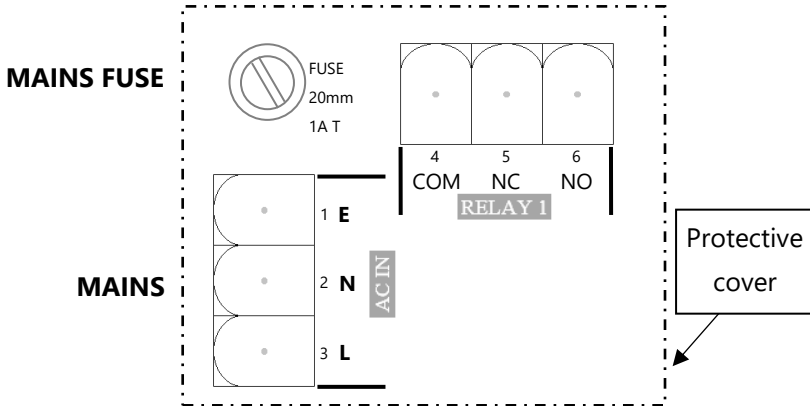

Important Information

Please note that all units are supplied for safety reasons with a 20mm 1AT fuse fitted as standard. Never operate the Ultra 4 with the protective cover removed.

An external switch or circuit breaker should be installed near to the Ultra 4 to allow the supply to be removed during installation and maintenance. In addition, the relay contacts should also have a means of isolating them from the Ultra 4.

Interconnecting cables must be adequately insulated in accordance with local regulations. Strip back 30 mm of the outer insulation of the cable. Strip 5 mm of insulation from the end of each conductor. Twist all exposed strands of the conductor together. Insert the stripped conductor into the terminal block as far as it will go and tighten the terminal block screw. Ensure that all strands are firmly clamped in the terminal block and that there is no excess bare conductor showing, and no stray strands.

DON'T FORGET

Before powering up the unit, ensure the protective terminal cover is in place.

Important Information

If the equipment is installed or used in a manner not specified in this manual, then the protection provided by the equipment may be impaired.

Preparation for Operation

Before switching on, check the following:

- ✓ The Ultra 4 is mounted correctly and is in a 'safe' area.
- ✓ The power supply is correctly installed.
- ✓ If powered by AC the protective cover is fitted.
- ✓ The relays are connected correctly.
- ✓ Any controlled equipment, e.g., motors, servos & valves, are not able to injure people or damage property.

Maintenance

There are no user serviceable parts inside Ultra 4, except the mains fuse. If you experience any problems with the unit, then please contact Pulsar Measurement for advice.

To clean the equipment, wipe with a damp cloth. Do not use any solvents on the enclosure.

Important Information

The unique DATEM software comes into operation as soon as power is applied and is designed to monitor a **moving level** or **target** with the **transducer** in a **fixed position**.

If, after any period of use, it should become necessary to move the transducer, for any reason, from its original operating position, switch off the Ultra 4, before proceeding, to prevent any undesirable updates to the DATEM trace. If after moving the transducer the reading is not as expected, please refer to **Chapter 10 Troubleshooting**.

CHAPTER 3 HOW TO USE YOUR ULTRA 4

Operating the Controls

There are two main operating modes for your Ultra 4, **Run Mode** and **Program Mode**. There is also a **Test Mode**, used for checking the set-up.

Display

The graphical display provides different levels of runtime information on the current mode of operation, and status of the remote communication. Whilst in the **Run Mode** the '**Main**' screen displays the current reading or measurement and its units of measure, along with status messages with regards to the Transducer, Echo reception and Fail-Safe Mode and relay activity. Additionally, it can be programmed to display up to 5 auxiliary variables and provide status messages on alarms, pumps etc. To scroll between run mode screens (**Echo**, **Settings**, **Trend**, **Info** and **Big**), use the left and right arrow keys.

The '**Echo**' screen shows the live echo trace of the point of measurement set up, with various viewing options available. For further information of the options available please refer to the '**Hot keys**' section later in this chapter.

The '**Settings**' screen shows details of the empty level, span and blanking distance for the measurement point set up. And if relays have been programmed, a graphical representation of the ON and OFF setpoints of the relay(s) are shown.

The '**Trend**' screen shows live measurement information depending on what is selected within the 'Trend Setup' parameters P260-274. Pressing the up and down arrow keys allows you to toggle between current and historical trending. Pressing the up and down arrow keys will toggle between the different trend logs being monitored as set up in 'Trend Setup'.

The '**Info**' screen is split into multiple pages. These give information such as the current time and date, details of the unit, if there is a SD card inserted and what it is logging, amongst other information. Pressing the up and down arrows allows you to move between the info pages.

The '**Big**' screen allows you to view the current measurement and measurement unit displayed on the Main screen in a larger, clearer font.

When in **Program mode** the display is used to read information using a sophisticated progressive menu system, where parameter numbers can be entered, their details viewed, and values changed to suit the application. During **Test Mode**, the display is used to monitor the simulated level. A bar graph is also provided which will provide a visual reading of the level, in percentage of span.

Run Mode

This mode is used once the Ultra 4 has been set up in program mode. It is also the default mode that the unit reverts to when it resumes operation after a power failure. When the Ultra 4 is switched on for the first time, it will display, in metres, the distance from the transducer face to the target. All relays by default are switched off.

After programming is complete, any relays that are set will operate when the level reaches the relevant setpoint, and the small square box will become solid. The letter in the box indicates the relay type.

Main Display

This screen provides information on the measurement point set up. Use the left and right arrow keys to scroll between screens

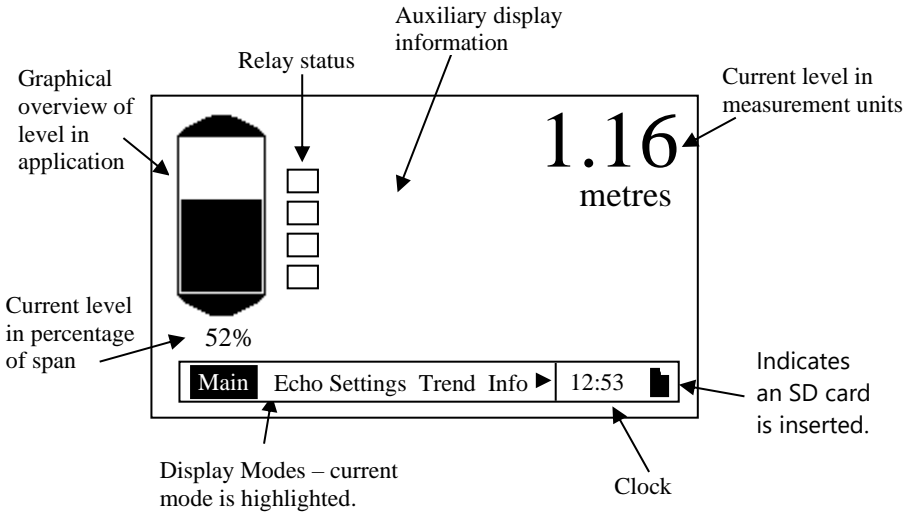

Pressing the up/down arrow keys will allow you to view the default information displays (non-programmable). The display returns to the default screen after 30 seconds. Pressing the 'up' key you can scroll through the following information:

1. Status, Strength, Confidence & Temperature
2. Distance, Level, Space & Temperature
3. Current mA output.

There is an SD card icon next to the clock; steady icon means the card is available, flashing is safe to eject, and not visible if there is no card present.

Echo Display

The Echo screen displays the instantaneous echo data captured from the transducer and presents it in the format shown in the illustration below.

Pressing the hotkeys on the keypad can display other trace information:

- F1 = Toggles Normalised trace.
- F2 = Toggles Loss limit line.
- F3 = Toggles Gate.

The text at the top right of the display indicates which of these display modes is on or off. Normal text for off, inverted text for on (example shown in the below diagram).

Below is an example of a typical level measurement application:

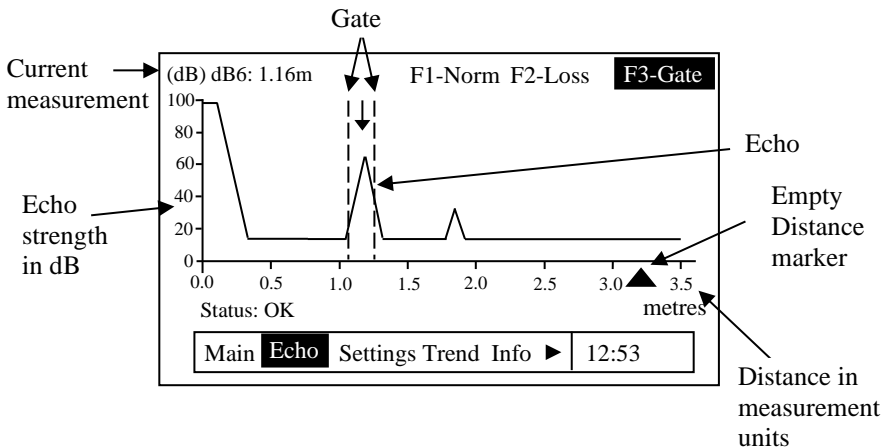

Settings Display

The Settings screen displays the transducer settings and has a bar-graph showing the measured value or as a percentage of maximum. To the left of the display:

- P105 = Empty Level
- P106 = Span
- P107 = Near Blanking.

Also, on this screen are indicators of any relays currently setup. The level icons → represent the level reading of the transducer. Relays that do not relate to the level (Miscellaneous) will be displayed without the graphical representation of setpoints but will however show the relay number and status. Below is an example of information on the Settings screen:

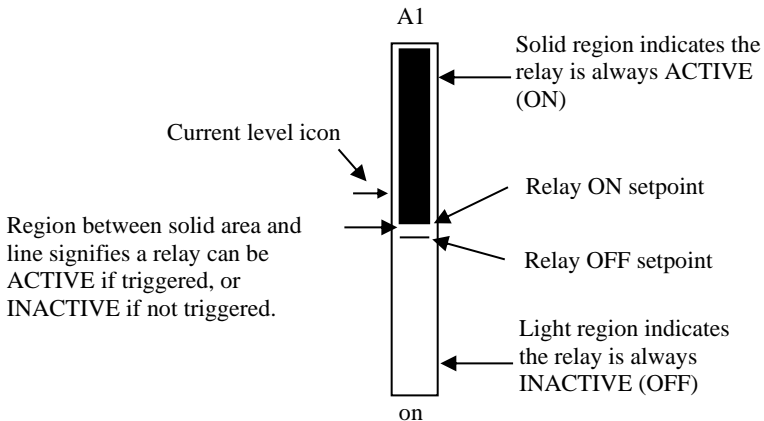
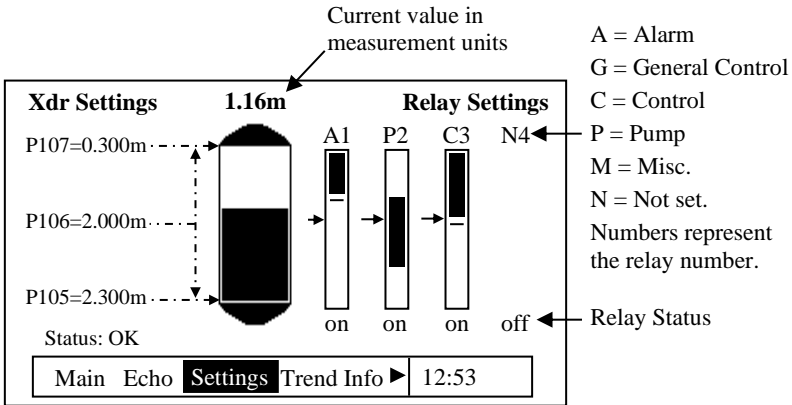

Trend Display

The Trend screen shows live and historical data for selectable measurements. You can toggle a display of up to 15 selectable measurements used in an application setup, which are then automatically updated every sample taken. The frequency of the trend sample taken varies in the user definable parameter **P129 - Sample interval**. Pressing the Up and Down buttons selects the different trending measurements (up to 15).

The LCD shows up to 210 points, and once the screen is full it scrolls left as each new sample is added. F1 and F2 symbols will appear on the screen indicating that you can scroll back to view the historical data and return to current measurements.

The files that the data is saved to is in the form of LymmddA.CSV. L – log file and yymmdd = year, month, and a = letter starting at 'A' in case more than one file is created. A new log file will be generated each day for that month.

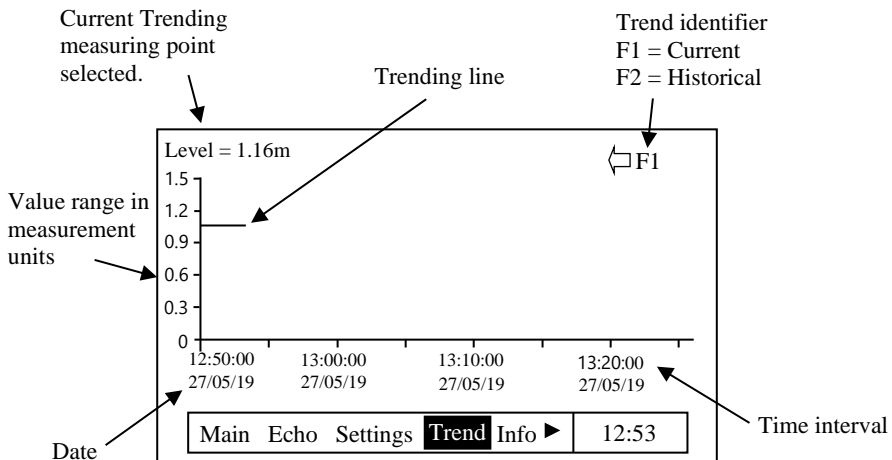

Info Display

The Info screen allows you to view the system details and a summary of the current application system setup.

Model	Ultra IV
System	Level/Volume
Customer	Pulsar
Version	1.0
Serial No.	000001
Site ID	000001
Day	Thursday
Date	27/05/19
Time	12:53:11

Main	Echo	Settings	Trend	Info	▶	12:53
------	------	----------	-------	-------------	---	-------

There are 11 pages in total that can be scrolled through to view different forms of information. Using the up and down arrows you can easily manoeuvre through the different pages. The page number is located at the top right of the display.

Page 1 – System Information

This shows the general information about the controller, details of this information are shown in the illustration above.

Page 2 – SD Card information

This shows information and status about the SD card (if inserted):

- Status of the card:

Scanning: The unit has detected a card is present and is checking it.

No Card: The unit has not detected a card is present.

Card Full: There is no storage room left on the SD card.

Ready: The card is available to have data written on it.

Bad card: A problem has been detected and the card is unusable.

Ejected: The [.] has been pressed and the SD card has not been ejected. If the [.] button is pressed accidentally the card becomes available again in 5 minutes.

- Card size inserted into the unit.
- Free space on the card.
- Used space on the card.
- File system type of the SD card.

Page 3 – Data logging Information

This shows up to date logging information of all measurement information. It also shows the sample interval that is currently set.

Page 4 – Trace logging Information

Trace logging is enabled by default, it can be disabled in program mode, if not required. Echo traces are logged to the SD card, where the file and format are TyymmddA and TyymmddA.DAT. Where 'T' indicates a trace file/folder, yymmdd are the year, month, and day the file and folder were created, and 'A' is a letter, starting with 'A' in case more than one file is created in a day. A new log file will be generated each day for that month. The .DAT suffix indicates that the files have been saved in such a way that they can be viewed using PC Suite (Ultra PC).

The display shows whether the trace logging is enabled. The **normal** interval is how often a trace is written/saved to the SD card, the **fault** interval is how often a trace is written/saved to the SD card when a fault occurs. The rest of the display shows settings for fault conditions, some of which are referenced to user-set limits.

Page 5 – Pump Diagnostics

This page is always visible, but it is only populated when pumps are programmed into the unit. The screen shows the following:

- Duty – The pump duty set for each pump e.g., ADB.
- SP1, SP2 & SP3 - The three setpoints associated with pumps.
- Closures – This is the number of closures for each relay.
- Status – Pump status, on or off. Off is shown in normal text where as On is in inverse text.
- Run – Total run times (in hours) since the relay was configured.
- Current level.

Page 6 – Event Log

This screen shows the date and time of the occurrence of various events, which are also written/saved to the SD card. The latest 9 events are displayed on the screen.

The event log file and formats are EyymmddA.CSV, where 'E' is for event, yymmdd are the year, month, and the day on which the file was created. And 'A' is a letter starting at A in case there is more than one file started on the same day. A new log file will be generated each day for that month.

Page 7 – RS232 settings and Comms settings

Information regarding the RS232 and comms settings are shown on this screen. The RS232 baud rate, number of bits, parity and number of stop bits for the RJ11 serial port is displayed. If the Ultra 4 has optional comms protocols enabled, the screen will show the device address and any associated bus parameters.

Page 8 – Point Settings

This page shows the settings for the measurement point:

- Transducer type.
- Mode, e.g., Volume.
- Material (liquid, solids, or closed tank).
- Empty level.
- Span.
- Fail Mode.

Page 9 – mA Out Settings

This page shows the information portraying the mA out:

- Range – Maximum range of the output.
- Mode – Measurement represented by the output.
- Low – Measured value indicated by the Low limit.
- High – Measured value indicated by the High Limit.
- Fail Mode – Output of current during a failed safe mode.
- Low Limit – Minimum output current.
- High Limit – Maximum output current.

Page 10 – 10-day totaliser log

- Displays date and flow totaliser information for the last ten days, the first on the list is the most recent and the last one is the oldest. When all 10 totaliser logs are full the oldest is pushed out and all totals increment through to allow the new days to be registered.

Page 11 – Echo information

- Displays current information relating to H.A.L.L (Height Above Loss Limit), Average noise, Peak Noise and Echo strength.

Big Display

The Big display shows the current measurement and measurement units being displayed on the Main screen, but in a much larger font for ease of reading.

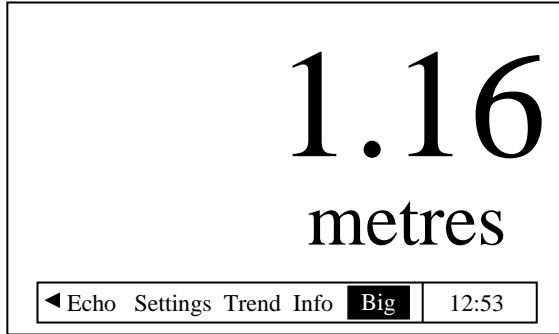

Pressing the F2 button will invert the screen, so that the screen has a black background with large white letters and numbers on the screen.

Note: The Big screen display will only show one auxiliary display option, the screen will alternate from the display above to a display like the one shown below (depending on the aux option chosen will depend on the information shown).

Auxiliary display information

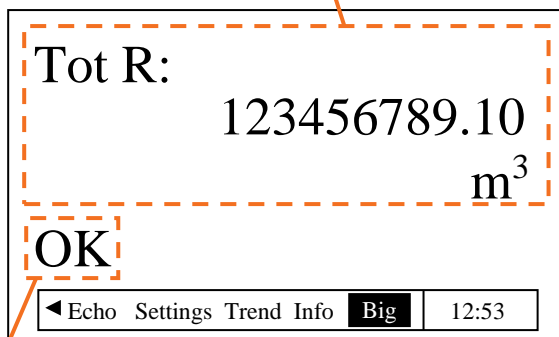

Transducer status

Program Mode

This mode is used to set up the Ultra 4 or change information already set, by using the built-in keypad Alternatively, the unit can be set up with a PC via the RS 232 Serial Interface.

Entering a value for each of the parameters that are relevant to your application defines all the programming information.

How to Access Program Mode

To enter **program mode**, you simply enter the passcode, via the keypad, followed by the ENTER key. The **default passcode** is **1997**, so you would press the following:

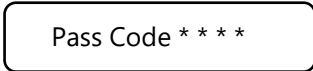



This will appear on the display of the unit, before pressing Enter.

Important Information

There is a time-out period of 30 minutes when in **program mode**, after which time **run mode** will be resumed if you do not press any keys.





Menu Keys

The menu keys have the following functions:

HOT KEY	RUN MODE	PROGRAM MODE
	<p>Used to scroll between the displays on the main display</p> <ol style="list-style-type: none"> 1. Displays Status, echo strength, echo confidence and temperature. 2. Displays Distance, Level, Space, Temperature and Head (when Ultra Wizard = Flow). 3. Displays echo confidence, H.A.L.L, average noise, peak noise. 4. Displays instantaneous mA output. If enabled, Daily, system and resettable totalisers are displayed. 5. Moves through different trending points setup on the Trend screen. 6. Moves through the different Info screens on the Info display. 	<p>Arrow keys for moving up and down the menu system. Also used in simulation mode to move the level up and down.</p>
	<p>Not used with Ultra 4.</p>	<p>Used to confirm each action (for example select a menu option) or when entering a parameter number or value. Also used to confirm questions asked by your Ultra 4 such as before restoring factory defaults.</p>
	<p>Not used with Ultra 4.</p>	<p>Used to navigate up a level in the menu system, and back to run mode. Used to cancel a value entered in error.</p>

Hot Keys

The hot keys have the following functions:

HOT KEY	RUN MODE	PROGRAM MODE
	Used to reset to the resettable totaliser on main screen. Used to display Normalised trace on the Echo screen. Switches trending so the historical trends on Trend screen can be viewed.	Clears the current value entered in a parameter.
	Used to display the Loss limit line in the Trace screen. Switches trending to view the current trends on the Trend screen. And also invert the screen on the big screen.	Changes Relay setpoints from measurement units to a percentage value.
	Used to display the Gate on the echo screen.	Reset parameter to default setting.
	Press this to eject the Micro SD card safely. If '.' is pressed but the card is not removed it becomes active again after 5 minutes.	Used for decimal parameter values.
	Not used with Ultra 4.	Toggle between positive and negative values.

Numeric Keys

These keys are used for entering numerical information during programming.

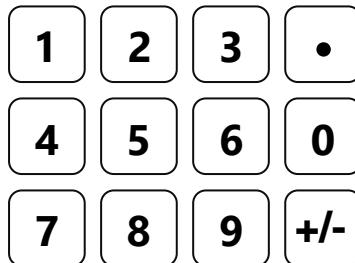

There are two means of editing parameters in the Ultra 4, using the menu system or directly accessing them. Each means of parameter editing is now explained.

Using the Menu System

The menu system has been designed to make the changing of parameters very simple. There are two levels of menu: **Main Menu** and **Sub Menu**.

At the top of the display, there is a line of text that displays the main menu system. Pressing the left and right arrow keys scrolls the display between the top-level menu items, (as shown below).

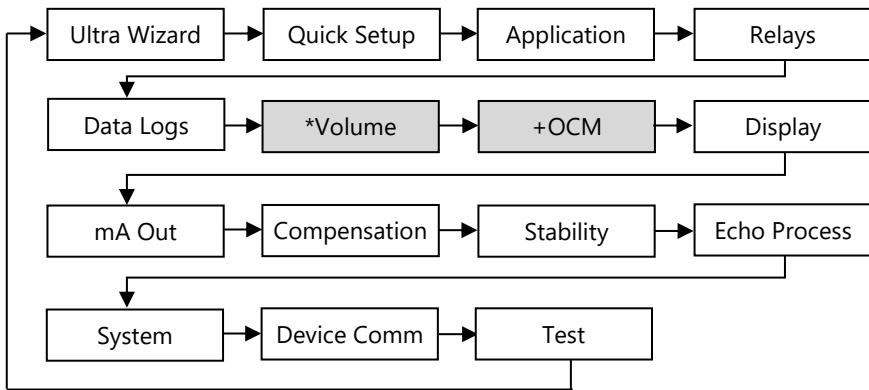

*This option becomes available when Ultra Wizard = Level/Volume.

+This option becomes available when Ultra Wizard = Flow.

As you press the cursor keys to scroll left and right between these, you can press ENTER or the down arrow at any time, to expand the sub menu. Each of these options, along with their sub-menus, are described later in this manual. When you move down into the sub-menu, you can scroll around using the arrow keys, press ENTER to go to the required section of parameters.

A scroll bar is shown where more options are available.

Once you have reached the relevant section, scroll through the parameters, and enter the necessary information. To enter the information, use the numeric keys and then press ENTER, you will then see the message "Saved!" If you press CANCEL, then the change you made will not be saved, and you will exit from the parameter to the menu options.

When you have finished, press CANCEL to go back to the previous level. When you have reached the top level, then the Ultra 4 will ask for confirmation before allowing you to go back into run mode. This is done by pressing ENTER at the display prompt 'Run Mode?'

Directly Editing Parameters

If you already know the number of the parameter, that you wish to look at or edit, simply type the number in at any time while you are in the menu system. Thus, if you are in either the menu or sub-menu level by pressing a numeric key, you can enter the parameter number directly and jump straight there. You cannot type a parameter number whilst at parameter level, only at one of the two menu levels.

When you are at a parameter, the text line rotates automatically displaying the parameter name, number, the applicable units, and the maximum and minimum figure you can enter. The top line shows the value you are setting.

Once you have accessed a parameter, you can either just look at it, or change it.

Once a parameter has been changed, press 'ENTER' and you will see the message "**Saved!**". If you press 'CANCEL', then the change you made will not be saved, and the message "**Unchanged!!**" will be displayed.

Test Mode

Test mode is used to simulate the application and confirm that all parameters and relay setpoints have been entered as expected. During simulation, there is a choice of whether the relays will change state (hard simulation) or not (soft simulation), but the relay boxes will always change colour as programmed (solid black fill or white fill), and the mA output will change in accordance with the chosen mode of operation. If you wish to test the logic of the system to which the **relays are connected**, select **hard simulation**, but if you **don't wish to change the relay state**, then select a **soft simulation**.

There are two simulation modes, automatic and manual. Automatic simulation will move the level up and down between empty level or the pre-determined **Start Level (P983)** and Pump/Control relay switch points, if you wish to change the direction of the level movement e.g. to go beyond relay setpoints, this can be done by using the arrow keys. In manual simulation, using the arrow keys will allow you to move the level up and down as required.

To enter simulation, first go to **program mode**. Using the menu system, select menu item '**Test**', then sub-menu item '**Simulation**'. Simply change the value of the parameter **P980** to one of the following:

- 1= Manual soft simulation
- 2= Automatic soft simulation
- 3= Manual hard simulation
- 4= Automatic hard simulation

To return to program mode press CANCEL, and test mode will end.

When in **manual** simulation, by default test mode will move the level by 0.1m steps. Altering the **increment (P981)** will change this value.

In **automatic** mode, the rate at which the level moves up and down is set by the **increment (P981)** in metres, the **rate (P982)** in minutes, which can be changed to make the level move up and down faster. E.g., if **increment (P981)** is set for 0.1m and **rate (P982)** is set to 1 min then the level will increase or decrease at a rate of 0.1m/min. To make the simulated level move slower, decrease the value in **increment (P981)** or increase the value in **rate (P982)**. To make the simulated level move faster, increase the value in **increment (P981)** or decrease the value in **rate (P982)**.

Using the Serial Interface

The RS232 serial interface is used to communicate between the Ultra 4 and a PC using the optional Ultra PC and other associated Pulsar software packages, to obtain information such as data logging and view echo traces upload, download and save parameter files. In addition, it can also be used to control or obtain information using a standard PC or other computer base equipment. To do so, the settings for control are as follows: **baud rate 19,200, 8 data bits, no parity, 1 stop bit.**

The device should be connected as shown in [Chapter 2 Ultra 4 Installation](#).

To use the device remotely, you need to **log on** to start, and **log off** when finished. When **logged on**, Ultra 4 will show '**Remote ON**' on the display, and "**Communicator OFF**" when **logged off**.

All commands should be followed by a carriage return. When logged on, the unit will respond either OK (or a value) if the command is accepted, or NO if it is not.

To log on, send the command

/ACCESS:pppp where pppp is the passcode (P922).

To log off, send the command

/ACCESS:OFF

To read a parameter value, send the command

/Pxxx where xxx is the parameter you wish to read, and the Ultra 4 will respond with the parameter value.

To set a parameter, send the command

/Pxxx:yy where xxx is the parameter number, and yy is the value you wish to set it to.

Other commands you can use are:

/DISTANCE (shows current distance)

/LEVEL (shows current level)

/SPACE (shows current space)

/RATE (shows current rate)

/VOLUME (shows current volume)

/TEMP (shows current temperature)

/CURRENTOUT1 (show the mA output 1 value)

/CURRENTOUT2 (show the mA output 2 value)

/BACKUP1 (take backup of parameters to area 1)

/BACKUP2 (take backup of parameters to area 2)

/RESTORE1 (restore parameters from area 1)

/RESTORE2 (restore parameters from area 2)

Please consult Pulsar Measurement or contact your local Pulsar representative for further details and a full list of available commands.

Parameter Defaults

Factory Defaults

When first installing the Ultra 4, or subsequently moving or using the unit on a new application, before proceeding to program the unit for its intended application it is recommended that you ensure that all parameters are at their default values by completing a **Factory Default P930**, as described in the relevant unit type **parameter guide**.

When you first switch the Ultra 4 on, it will be reading the **distance** from the face of the transducer to the surface. It will be indicating in **metres**, as shown on the display. All relays are set OFF.

The **date (P931)** and **time (P932)** in the Ultra 4 were set at the factory, but may need checking, and amending if, for example the application is in a time zone other than GMT, see relevant parameter listing for full details.



In some applications, it is easier to empty the vessel, take a reading from the Ultra 4 for distance and then setup the empty level to this figure.

Once you are satisfied with the installation, and Ultra 4 is reading what you would expect in terms of distance from the face of the transducer to the material level, then you can proceed with programming, for the intended application. It is sensible to program all the required parameters at the same time. The system will be then set-up.



The span is automatically calculated from the empty level, so the empty level should be entered first.

CHAPTER 4 ULTRA WIZARD

The Ultra Wizard menu allows you to turn Ultra 4 into **anyone** of **three** dedicated ultrasonic devices to exactly suit the requirements of your application.

Enter Program Mode

First you need to go from run mode into program mode. Assuming the passcode is the default 1997, then you should enter the following on the keypad:



Choose Ultra Wizard

Now you need to go into the quick setup. You will see on the menu the words 'Quick Setup', which is the first item on the menu system. Try pressing the two arrow keys to see some more menu options, but return to Quick Setup, and press

- 1 = Level or Volume measurement (Level/Vol)**
- 2 = Pump Control (Pump)**
- 3 = Open Channel Flow measurement (Flow)**

Once you have selected the application of your choice the Ultra 4 will be configured to the system type specific to that task. And you can continue to set up the controller with ease.

Ultra 4 - Level / Volume

If you require to set up a level or volume application, with or without a choice of control functions, use the arrow keys to highlight Level/Volume or press "1" followed by "ENTER" the message "Saved" followed by "Loading ***" will be displayed and your Ultra 4 will be configured to allow the setup for level/volume applications. Confirmation that configuration has been completed will be the unit returning to the Ultra Wizard selection and the setup you have chosen will be displayed. You can now continue in the unit advancing to the relevant "Quick Setup" menu.

For full details on how to programme the Ultra 4 for level/volume, using the Quick Setup Menu, please proceed to Chapter 5 Level/Volume. For a full description of all features and parameters please refer to Chapter 8 Parameter Listing and Description.

Programming the controller for level/volume, provides the ability to convert level measurement to enable the contents of a vessel to be displayed in volume, along with control functions, for a complete range of vessel shapes. Also available within the unit is a customised 32-point calibration routine which also permits the calculation of volume in non - standard vessels.

The Ultra 4 can measure from zero to 40 m from the face of the transducer to the surface being monitored, dependent on the transducer used. Details of level, space, distance, and units of volume can be shown on the display. The four user-definable relays with individual setpoints can be programmed to activate devices such as pumps or other control equipment.

The 4-20 mA output is fully programmable to provide an output relative to level, space, distance or volume of the application being measured.

Ultra 4 - Pump control

Programming the controller for pump control, provides a complete range of pump "duties" readily available to the user.

The Ultra 4 can measure from zero to 40m from the face of the transducer to the surface being monitored, dependent on the transducer used. Details of level, space or distance can be shown on the display. The four user definable relays with individual setpoints can be programmed to activate alarms, pump starters, or other control equipment.

The 4-20 mA output is fully programmable to provide an output relative to level, space, or distance. If you require to set up a pump application, then

use the arrow keys to highlight Pump or press "2" followed by "ENTER" the message "Saved" followed by "Loading ****" will be displayed and your Ultra 4 will be configured to allow the setup for pump applications.

Confirmation that configuration has been completed will be the unit returning to the Ultra Wizard selection and the setup you have chosen will be displayed. You can now continue in the unit advancing to the relevant "Quick Setup" menu.

For full details on how to programme the Ultra 4 for Pump control, using the Quick Setup Menu, please proceed to Chapter 6 Pump. For a full description of all features and parameters please refer to Chapter 8 Parameter Listing and Description.

Ultra 4 - Flow

If you require to set up a flow application, then use the arrow keys to highlight Flow or press "3" followed by "ENTER" the message "Saved" followed by "Loading ****" will be displayed and your Ultra 4 will be configured to allow the setup for flow applications. Confirmation that configuration has been completed will be the unit returning to the Ultra Wizard selection and the setup you have chosen will be displayed. You can now continue in the unit advancing to the relevant "Quick Setup" menu.

For full details on how to programme the Ultra 4 for flow, using the Quick Setup Menu, please proceed to Chapter 7 Flow. For a full description of all features and parameters please refer to Chapter 8 Parameter Listing and Description.

Programming the controller for Open Channel Flow Measurement (OCM) provides comprehensive flow monitoring with data logging and control functions for a complete range of flumes, weirs and channels. Flow calculations to the British Standard BS3680 are available within the firmware together with calculations for a wide variety of other primary elements. Also available within the unit is a customised 32-point calibration routine which also permits the flow measurement of non - standard flumes and weirs.

The Ultra 4 can measure from zero to 16m from the transducer to the surface being monitored, dependent on the transducer used. Details of level, space, distance, head, or flow can be show on the display along with a totaliser if desired. The four user-definable relays with individual setpoints can be programmed to activate devices such as pumps, samplers, remote totalisers, or other control equipment.

The 4-20 mA output is fully programmable to provide an output relative to level, space, distance, head, average flow, or flow.

CHAPTER 5 LEVEL / VOLUME

This quick set-up guide shows you how to get up and running within a few minutes of installing your Ultra 4. As outlined in [Chapter 4 Ultra Wizard](#) of this manual the unit type can set up to monitor Level/Volume, Pump control or Flow. The following steps show you the quick setup for each system type.

System type selection

Before proceeding ensure that the **Ultra Wizard = 1 Level/Volume, 2 = Pump or 3 = Flow**. For further details, see [Chapter 4 Ultra Wizard](#) of this manual.

Enter Program Mode

First you need to go from run mode into program mode. Assuming the passcode is the default 1997, then you should enter this.



Pass Code * * * *

This will appear on the display of the unit, before pressing Enter.

Choose Quick Setup

Now you need to go into the quick setup. You will see on the display the words 'Ultra Wizard', press the 'right hand' arrow key and this will take you to the 'Quick Setup' menu option. Try pressing either of the two arrow keys to see some more menu options, but return to Quick Setup, and press



This takes you to the 'Quick Setup Menu.'



This takes you to the common applications menu, and several options will appear on the display.

Level or Volume Application

When Ultra Wizard = 1, Level/Volume there are two categories of application, which are all described later in this chapter. They are **level** or **volume**, both with the choice of control functions and alarms.

If you want to set-up a basic **level monitoring** application, as described in **example 1**, then choose option 1.

If you want to set-up a **level monitoring** application with **control relays**, as described in **example 2**, then choose 1 and choose either **control down** (option 1) or **control up** (option 2).

If you want to set-up a **volume** application, as described in the following **example 3**, then choose option 2.

Once you have chosen your application you will be able to choose a series of parameters with the options detailed in **Chapter 7** to setup your application. Once all the parameters have been set in the quick setup you can return to run mode, or alternatively if you have more advanced parameters to setup, you can access these through the menu system, to complete the programming of the unit.

Quick Setup

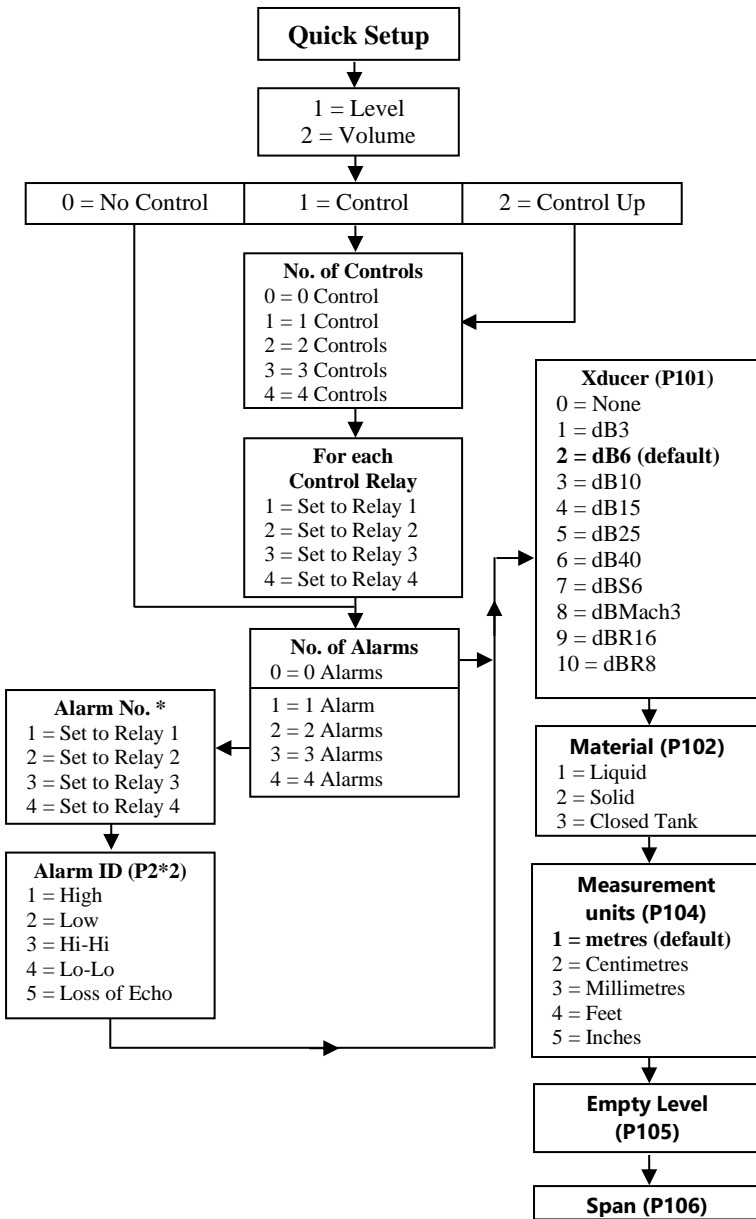

Saving Parameters.... Please wait

If you have selected a Volume Application, you will now be prompted to enter details required for the calculation of your volume application.

PARAMETER	DEFAULT	DESCRIPTION
P600 Vessel Shape	0 = Cylinder Flat Base	Shape of vessel being monitored. Select from the options below: 0 = Cyl. Flat Base (default) 1 = Rect. Flat Base 2 = Cone Base 3 = Pyram. Base 4 = Parab. Base 5 = Half Sphere 6 = Cyl. Sloped 7 = Rect. Sloped 8 = Cyl. Flat 9 = Cyl. Parabolic 10 = Sphere 11 = Uni. Linear
P601–P603 Vessel Dimensions	Dependent on vessel shape selected	Enter vessel dimensions as required.
P605 Volume units	3 = Cubic metres	Selects volume units required from the list below: 1 = Tons 2 = Tonnes 3 = Cubic metres (default) 4 = Litres 5 = UK Gallons 6 = US Gallons 7 = Cubic Feet 8 = Barrels 9 = Lbs (pounds)
P607 Max Volume	Read Only	Displays the calculated Volume in P605 units.

For More Options Hit Enter...

PARAMETER	DEFAULT	DESCRIPTION
P213 / P214 Relay 1 ON/OFF setpoints	Factory preset as a % to appropriate level according to the span already entered. See tables below	Either Alarm or Level control. Depends on application.
P223 / P224 Relay 2 ON/OFF setpoints	Factory preset as a % to appropriate level according to the span already entered. See tables below	Either Alarm or Level control. Depends on application.
P233 / P234 Relay 3 ON/OFF setpoints	Factory preset as a % to appropriate level according to the span already entered. See tables below	Either Alarm or Level control. Depends on application.
P830 mA Out Range	2 = 4 to 20mA	Determines the mA output range. 0 = Off 1 = 0 to 20mA 2 = 4 to 20mA 3 = 20 to 0mA 4 = 20 to 4mA.
P870 Fill Damping	10m/min	Rate of maximum fill rate (set above the actual fill rate of the vessel).
P871 Empty Damping	10m/min	Rate of maximum empty rate (set above the actual rate of the vessel).

Relay Setpoints Table

The default values used for determining the **relay setpoints**, when setting **Alarms** and **Control** relays, via the **Quick Setup** menu are entered as a % of span and are as follows:

APPLICATION	NO. OF CTL RELAYS	CTL RELAY NUMBER	ON SETPOINT	OFF SETPOINT
Control Down	One	Control 1	80%	20%
Control Down	Two	Control 1	80%	20%
		Control 2	70%	20%
Control Down	Three	Control 1	80%	20%
		Control 2	70%	20%
		Control 3	60%	20%
Control Down	Four	Control 1	80%	20%
		Control 2	70%	20%
		Control 3	60%	20%
		Control 4	50%	20%

APPLICATION	NO. OF CTL RELAYS	CTL RELAY NUMBER	ON SETPOINT	OFF SETPOINT
Control Up	One	Control 1	20%	20%
Control Up	Two	Control 1	20%	20%
		Control 2	30%	20%
Control Up	Three	Control 1	20%	20%
		Control 2	30%	20%
		Control 3	40%	20%
Control Up	Four	Control 1	20%	20%
		Control 2	30%	20%
		Control 3	40%	20%
		Control 4	50%	20%

RELAY FUNCTION	RELAY ID	ON SETPOINT	OFF SETPOINT
Alarm	HiHi	90%	85%
Alarm	High	85%	80%
Alarm	Low	10%	15%
Alarm	LoLo	5%	10%

Example 1 Level Monitoring with Alarms

A vessel, containing liquid that has a variation in level that is to be monitored, with a high-level alarm set on Relay 1 and low-level alarm set on Relay 2.

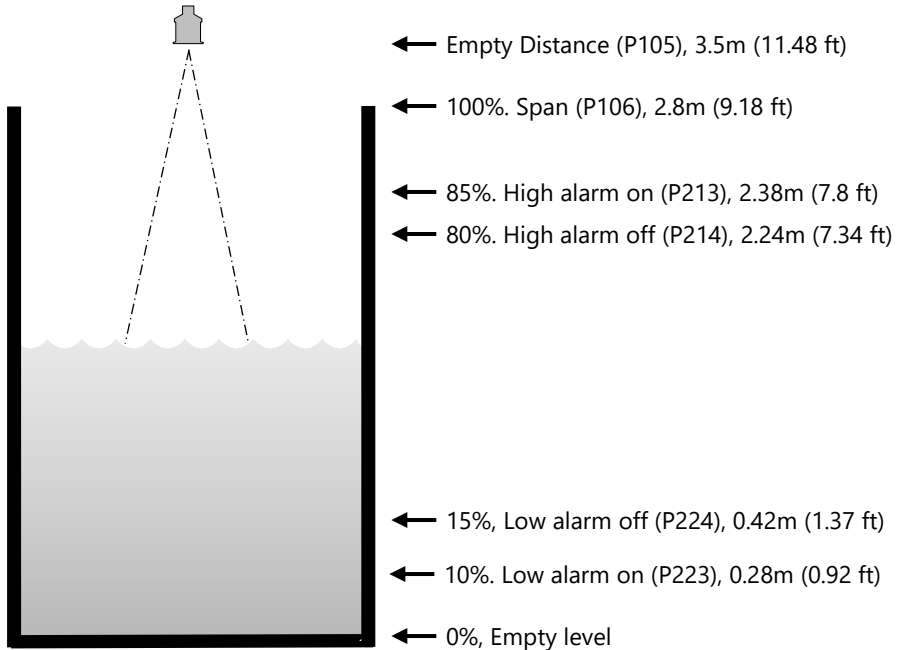

In this example, when the level rises to 2.38m (7.8 ft), relay 1 will come on until the level drops to 2.24m (7.34 ft) when it will turn off. If the level drops to 0.28m (0.92 ft), then relay 2 will come on until it rises 0.42m (1.37 ft) when it will turn off.

The display will show the level in the tank.

The mA output will be representative of level where 4mA = empty level (0%) and 20mA = 2.8m (9.18 ft) (100%).

To program the unit for **Example 1** using the **Quick Setup** menu, proceed as follows.

If required access **Program Mode**, by keying in the passcode **1997** and press **ENTER**.

Using the 'right' arrow key, go to the **Quick Setup** menu and press **ENTER**. And as prompted, by the questions, select the relevant option and press **ENTER**.

QUESTION	OPTION
Level/Volume	1 = Level App.
No. of alarms	2 = 2 Alarms
Type alarm 1	1 = High
Alarm no.1	1 = Set to relay 1
Type alarm 2	2 = Low
Alarm no.2	2 = Set relay 2
Xducer (P101)	2 = dB6
Material (P102)	1 = Liquid
Measurement units (P104)	1 = Metres
Empty Level (P105)	3.5m
Span (P106)	2.8m

Programming is now complete, and the unit can be returned to the run mode, press **CANCEL** until **Run Mode?** Is displayed on the LCD press **ENTER**, and the Ultra 4 will return to the **Run Mode**.

Important Notice

If relay setpoints do not meet the exact requirements of the application, they can be modified to suit by pressing ENTER when, "For More Options Hit Enter", is displayed, and entering new values to relay setpoints as required. Alternatively, the relevant relay setpoint can be accessed either by the main menu system or directly via parameter number and changed as necessary.

Example 2 Level Monitoring and Control (up or down)

A vessel, containing a liquid that has a variation in level that is to be monitored, and when the level reaches a specific point, the vessel is pumped down, with the fluid being transferred to another process. The pump will be assigned to Relay 1 a High Alarm to Relay 2 and Low Alarm to Relay 3.

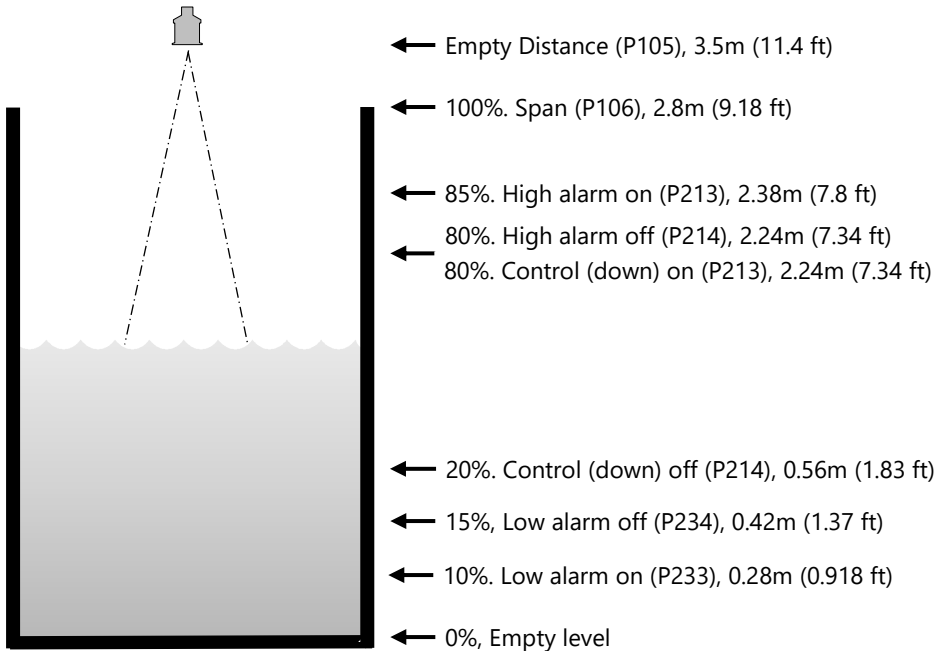

In this example, there is a **control** relay (relay 1), which will come on if the level rises to 2.24m (7.80 ft) and go off when the level drops to 0.56m (1.83 ft) (**control down**). If the level rises to 2.38m (7.80 ft), then the high-level alarm (relay 2) will come on until the level drops to 2.24m (7.34 ft). If the level falls to 0.28m (0.918 ft), then the low-level alarm (relay 3) will come on until the level rises to 0.42m (1.37 ft).

Alternatively, if it is a **control up** application, then the on and off points for the control relay are reversed, so the control device comes on when the level is at 0.56m (1.83 ft) and goes off when it rises to 2.24m (7.34 ft). The display will show the level in the tank and the mA output will be representative of level where 4mA = empty level (0%) and 20mA = 2.8m (9.18 ft) (100%).

To program the unit for **Example 2** using the **Quick Setup** menu, proceed as follows.

If required access **Program Mode**, by keying in the passcode **1997** and pressing **ENTER**.

Using the 'right' arrow key, go to the **Quick Setup** menu press **ENTER**. And as prompted, by the questions, select the relevant option and press **ENTER**

QUESTION	OPTION
Level/Volume	1 = Level App.
Control	1 = Control down
No. of controls	1 = 1 Relay
Control no.1	1 = Set to relay 1
No. of alarms	2 = 2 Alarms
Type alarm 1	1 = High
Alarm no.1	1 = Set to relay 2
Type alarm 2	2 = Low
Alarm no.2	The unit knows that only Relay 3 is available and so will automatically set Alarm 2 to Relay 3.
Xducer (P101)	2 = dB6
Material (P102)	1 = Liquid
Measurement units (P104)	1 = Metres
Empty Level (P105)	3.5m
Span (P106)	2.8m

Programming is now complete, and the unit can be returned to the run mode, press **CANCEL** until **Run Mode?** Is displayed on the LCD press **ENTER**, and the Ultra 4 will return to the **Run Mode**.

Important Notice

If relay setpoints do not meet the exact requirements of the application, they can be modified to suit by pressing ENTER when, "For More Options Hit Enter", is displayed and entering new values to relay setpoints as required. Alternatively, the relevant relay setpoint can be accessed either by the main menu system or directly via parameter number and changed, as necessary.

Example 3 Volume Application

A cylindrical tank with a diameter of 2m and a flat base that is typically used to temporarily hold liquid, and you wish to know the volume of liquid. You also require a high and low alarm and when the level reaches a specific point, the vessel is pumped down, with the fluid being transferred to another process.

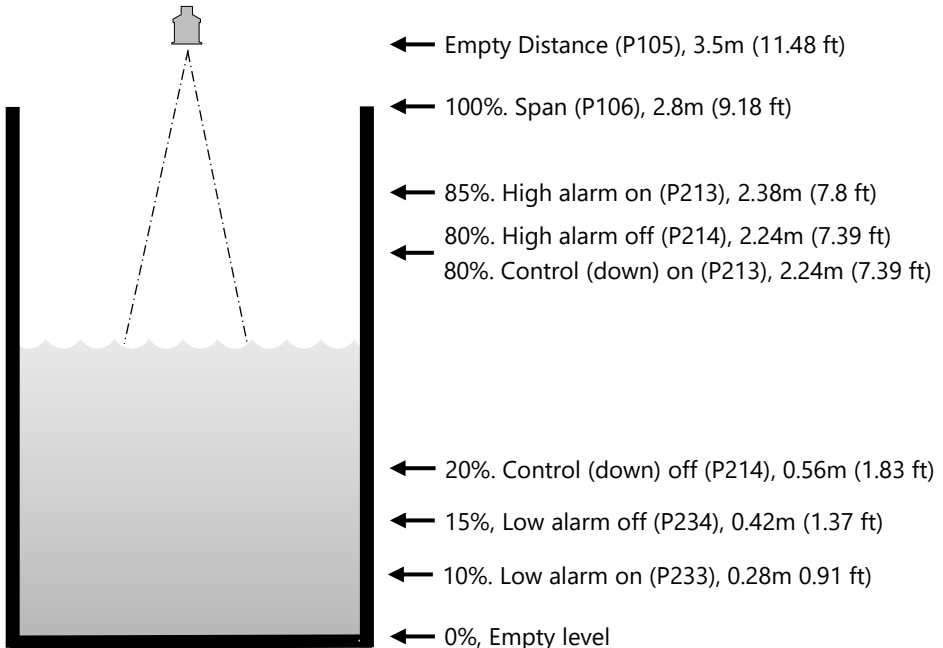

In this example, there is a pump (relay 1), which will come on if the level rises to 2.24m (7.39 ft) and go off when the level drops to 0.56m (1.83 ft).

(Control down). If the level rises to 2.38m (7.8 ft), then the high-level alarm (relay 2) will come on until the level drops to 2.24m (7.39 ft). If the level falls to 0.28m (0.91 ft), then the low-level alarm (relay 3) will come on until the level rises to 0.42m (1.37 ft).

The display will show the volume of fluid in the tank and the mA output will be representative of Volume where 4mA = empty (0%) and 20mA = Max Volume (100%).

To program the unit for **Example 3** using the **Quick Setup** menu, proceed as follows. If required access **Program Mode**, by keying in the passcode **1997** and press **ENTER**. Using the 'right' arrow key, go to the **Quick Setup** menu and press **ENTER**. And as prompted, by the questions, select the relevant option and press **ENTER**.

QUESTION	OPTION
Level/Volume	1 = Level App.
Control	1 = Control down
No. of controls	1 = 1 Relay
Control no.1	1 = Set to relay 1
No. of alarms	2 = 2 Alarms
Type alarm 1	1 = High
Alarm no.1	1 = Set to relay 2
Type alarm 2	2 = Low
Alarm no.2	The unit knows that only Relay 3 is available and so will automatically set Alarm 2 to Relay 3.
Xducer (P101)	2 = dB6
Material (P102)	1 = Liquid
Measurement units (P104)	1 = Metres
Empty Level (P105)	3.5m
Span (P106)	2.8m
Vessel shape (P600)	0 = Cylindrical flat base
Vessel dimensions	Enter vessel dimensions as requested (depends on vessel shape chosen)
Volume units	Select as required
Max Volume (Read only)	Displays the Max volume as calculated by the Ultra 4. This is a read only parameter.

This example is for a cylindrical flat-bottomed vessel. See **P600 Vessel Shape** in the following **Parameter Guide**, for a description of all the other vessel shapes you could select, and dimensions required. Programming is now complete, and the unit can be returned to the run mode. To do this, press **CANCEL** until **Run Mode?** is displayed on the screen. Press **ENTER**, and the Ultra 4 will now return to **Run Mode**

Important Notice

If relay setpoints do not meet the exact requirements of the application, they can be modified to suit by pressing ENTER when, "For More Options Hit Enter", is displayed and entering new values to relay setpoints as required. Alternatively, the relevant relay setpoint can be accessed either by the main menu system or directly via parameter number and changed, as necessary.

CHAPTER 6 PUMP

When Ultra Wizard = 2 Pump

This quick set-up guide shows you how to get up and running within a few minutes of installing your Ultra 4.

Before proceeding ensure that the **Ultra Wizard = 2 Pump** (Vantage 3). For further details, see [Chapter 4 Ultra Wizard](#).

Enter Program Mode

First you need to go from run mode into program mode. Assuming the passcode is the default 1997, then you should enter this.



Pass Code * * * *

This will appear on the display of the unit, before pressing Enter.

Choose Quick Setup

Now you need to go into the quick setup. You will see on the display the words 'Ultra Wizard', press the 'right hand' arrow key and this will take you to the 'Quick Setup' menu option. Try pressing either of the two arrow keys to see some more menu options, but return to Quick Setup, and press



This takes you to the 'Quick Setup Menu.'



This takes you to the common applications menu, and several options will appear on the display.

Pump Application

When Ultra Wizard = 2, Pump there are two categories of application, which are all described later in this manual. They are pump down (sump control) or pump up (reservoir control) all with the choice of alarms.

If you want to set-up a basic level monitoring application, as described in example 4, then choose option 1.

If you want to set-up a pump down (sump control) application, as described in example 5 then choose option 2.

If you want to set-up a pump up (reservoir control) application, as described in the following example 6 then choose option 3.

Once you have chosen your application you will be asked a series of questions which are answered by choosing the appropriate option as detailed in the flow chart on the following page. Once all the parameters have been set in the quick setup you can return to run mode, or alternatively if you have more advanced parameters to setup you can access these through the menu system, to complete the programming of the unit.

Quick Setup Menu

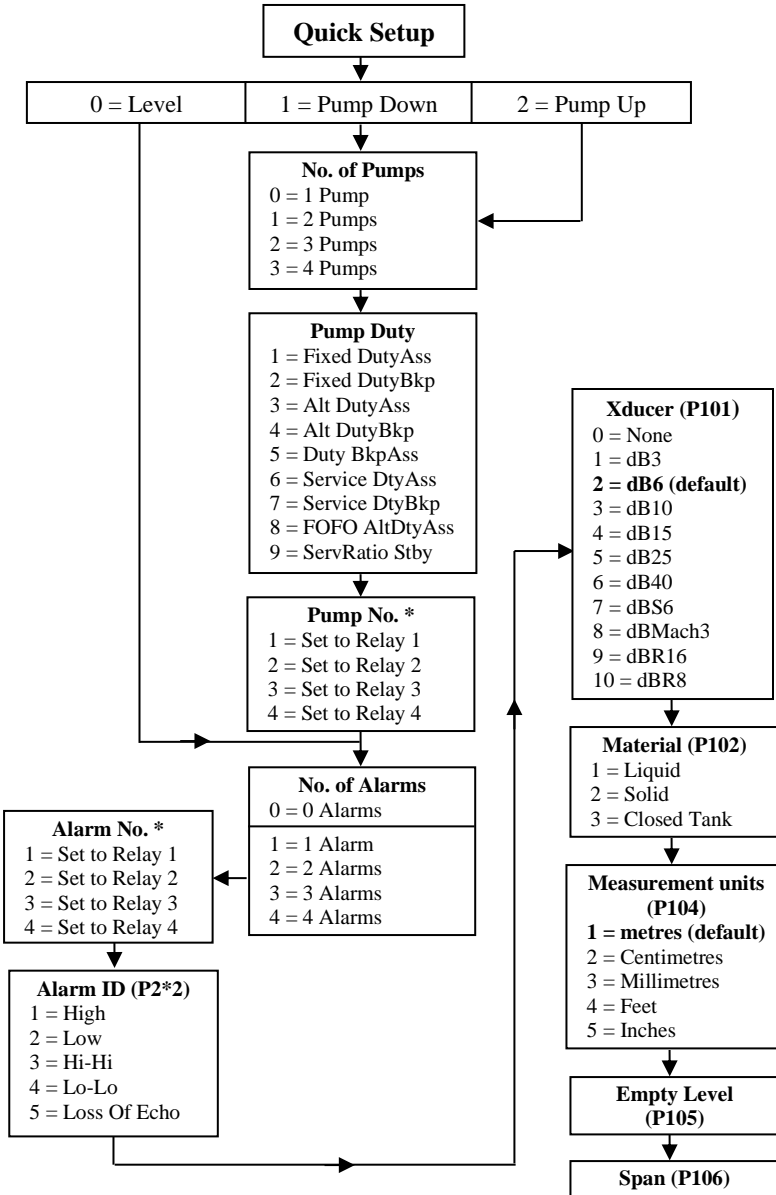

Saving Parameters.... Please wait

PARAMETER	DEFAULT	DESCRIPTION
P213 / P214 Relay 1 ON/OFF setpoints	Factory preset as a % to appropriate level according to the span already entered. See tables below	Either Alarm or Level control. Depends on application.
P223 / P224 Relay 2 ON/OFF setpoints	Factory preset as a % to appropriate level according to the span already entered. See tables below	Either Alarm or Level control. Depends on application.
P233 / P234 Relay 3 ON/OFF setpoints	Factory preset as a % to appropriate level according to the span already entered. See tables below	Either Alarm or Level control. Depends on application.
P233 / P234 Relay 3 ON/OFF setpoints	Factory preset as a % to appropriate level according to the span already entered. See tables below	Either Alarm or Level control. Depends on application.
P830 mA Out Range	2 = 4 to 20mA	Determines the mA output range. 0 = Off 1 = 0 to 20mA 2 = 4 to 20mA 3 = 20 to 0mA 4 = 20 to 4mA.
P870 Fill damping	10m/min	Rate of maximum fill rate (set above the actual fill rate of the vessel).
P871 Empty damping	10m/min	Rate of maximum empty rate (set above the actual empty rate of the vessel).

Relay Setpoints Table

The default values used for determining the **relay setpoints**, when setting **Alarms** and **Control** relays, via the **Quick Setup** menu are entered as a % of span and are as follows:

APPLICATION	NO. OF CTL RELAYS	CTL RELAY NUMBER	ON SETPOINT	OFF SETPOINT
Pump Down	One	Pump 1	50%	20%
Pump Down	Two	Pump 1	50%	20%
		Pump 2	70%	20%
Pump Down	Three	Pump 1	50%	20%
		Pump 2	60%	20%
		Pump 3	70%	20%
Pump Down	Four	Pump 1	40%	20%
		Pump 2	50%	20%
		Pump 3	60%	20%
		Pump 4	70%	20%

APPLICATION	NO. OF CTL RELAYS	CTL RELAY NUMBER	ON SETPOINT	OFF SETPOINT
Control Up	One	Control 1	50%	20%
Control Up	Two	Control 1	50%	20%
		Control 2	30%	20%
Control Up	Three	Control 1	50%	20%
		Control 2	40%	20%
		Control 3	30%	20%
Control Up	Four	Control 1	60%	20%
		Control 2	50%	20%
		Control 3	40%	20%
		Control 4	30%	20%

RELAY FUNCTION	RELAY ID	ON SETPOINT	OFF SETPOINT
Alarm	HiHi	90%	85%
Alarm	High	85%	80%
Alarm	Low	10%	15%
Alarm	LoLo	5%	10%

Example 4 Level Monitoring with Alarms

A vessel, containing liquid that has a variation in level that is to be monitored, with a high-level alarm set on Relay 1 and low-level alarm set on Relay 2.

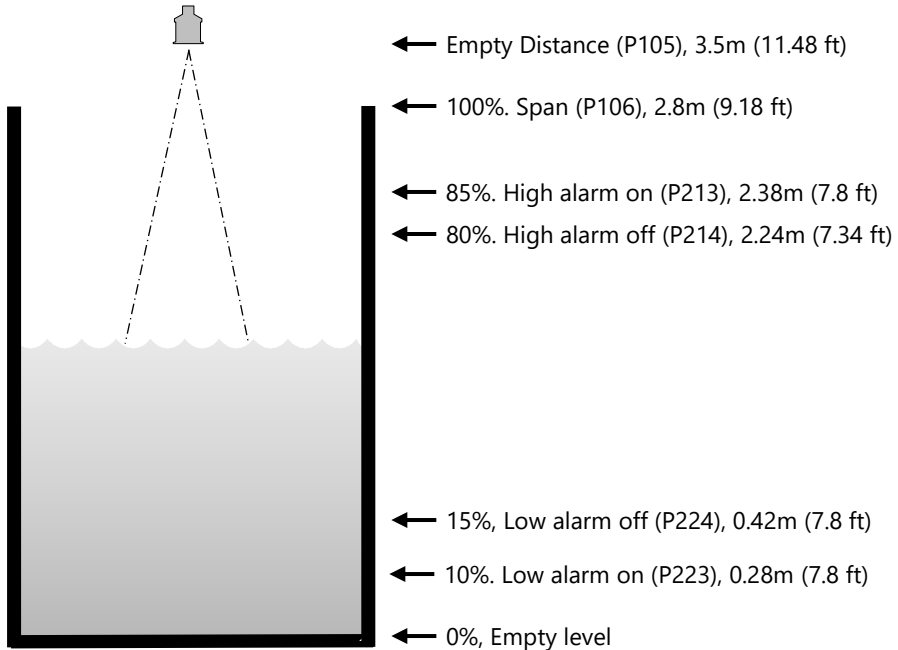

In this example, when the level rises to 2.38m (7.80 ft), relay 1 will come on until the level drops to 2.24m (7.34 ft) when it will turn off. If the level drops to 0.28m (0.91 ft), then relay 2 will come on until it rises 0.42m (1.37 ft) when it will turn off.

The display will show the level in the tank.

The mA output will be representative of level where 4mA = empty level (0%) and 20mA = 2.8m (9.18 ft) (100%).

To program the Ultra 4 for **Example 4 Level Monitoring with Alarms** by using the Quick Setup menu proceed as follows. If required to access **Program Mode**, key in the **passcode** 1997 and press **ENTER**

At the **Quick Setup** menu press **ENTER** and as prompted, by the questions, select the relevant option and **ENTER**.

QUESTION	OPTION
Level/Pump up or down	1 = Level App.
No. of alarms	2 = 2 Alarms
Type alarm 1	1 = High
Alarm no.1	1 = Set to relay 1
Type alarm 2	2 = Low
Alarm no.2	2 = Set relay 2
Xducer (P101)	2 = dB6
Material (P102)	1 = Liquid
Measurement units (P104)	1 = Metres
Empty Level (P105)	3.5m
Span (P106)	2.8m

Programming is now complete, and the unit can be returned to the run mode, press **CANCEL** until **Run Mode?** Is displayed on the LCD press **ENTER**, and the Ultra 4 will return to the **Run Mode**.

Important Notice

If relay setpoints do not meet the exact requirements of the application, they can be modified to suit by pressing ENTER when, "For More Options Hit Enter", is displayed, and entering new values to relay setpoints as required. Alternatively, the relevant relay setpoint can be accessed either by the main menu system or directly via parameter number and changed as necessary.

Example 5 Sump Control (pump down)

A sump is typically used to temporarily hold water or effluent, and when the level reaches a specific point, the sump is pumped down, with the fluid being transferred to another process.

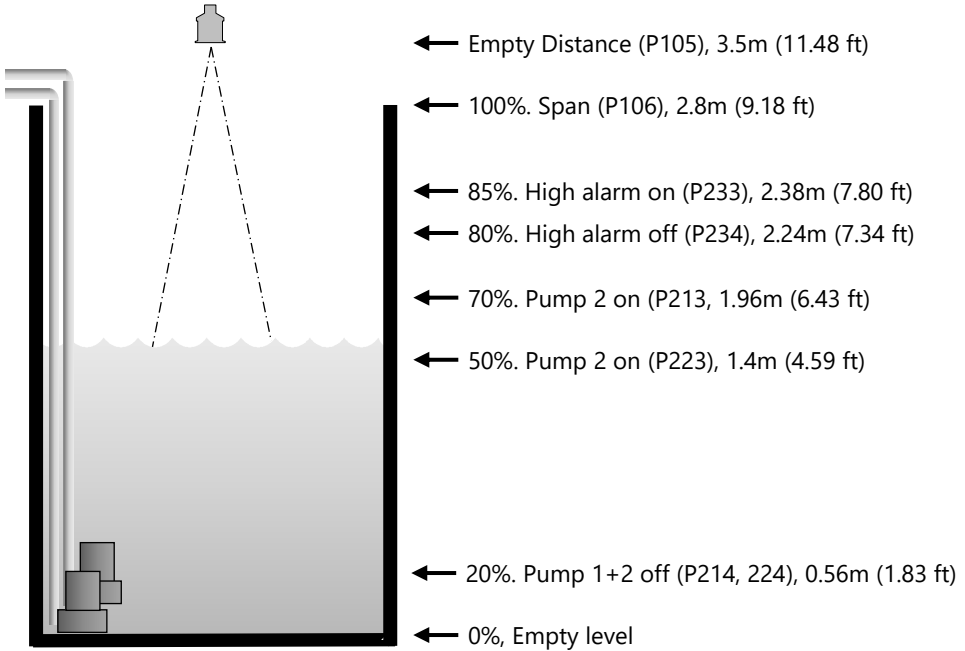

A sump is typically used to temporarily hold water or effluent, and when the level reaches a specific point, the sump is then pumped down, with the fluid being transferred to another process. In this example, there are two pumps, which will be set to **alternate duty assist**, so they come on alternately. Pump 1 is to be set to relay 1, pump 2 to relay 2, and the high-level alarm to relay 3.

This will operate as follows. During normal operation, **pump 1** will come on at 1.4m (4.59 ft) and pump down to 0.56m (1.83 ft). The setpoints are then shifted to **pump 2**, which will come on first next time the pumps are called to run. During peak periods, when **pump 1** cannot cope, **pump 1** will come on at 1.4m (4.59 ft), **pump 2** will come on at 1.96m (6.43 ft) and pump down to 0.56m (1.83 ft). The setpoints are then shifted to **pump 2**, which will come on **first next time**.

If neither pump can cope, and the level rises to 2.38m (7.8 ft), then the alarm relay (relay 3) will come on and go off when the level falls to 2.24m (7.34 ft). This will indicate insufficient capacity of the pumps. The display will show the level in the sump and the mA output will be representative of level where 4mA = empty level (0%) and 20mA = 2.8m (9.18 ft) (100%).

To program the Ultra 4 for **Example 5 Sump control (pump down)** by using the **Quick Setup** menu proceed as follows. If required to access **Program Mode**, key in the **passcode** 1997 and press **ENTER**

At the **Quick Setup** menu press **ENTER** and as prompted, by the questions, select the relevant option and **ENTER**.

QUESTION	OPTION
Level/Pump Up or Down	2 = Pump Down
No. of Pumps	2 = 2 Pumps
Pump Duty	3 =Alt Duty Assist
Pump No. 1	1 = Set to relay 1
Pump No. 2	2 = Set to relay 2
Type Alarm 1	1 = High Alarm
Alarm No. 1	The unit knows that only Relays 3 & 4 are available and will only display these for use.
Xducer (P101)	2 = dB6
Measurement units (P104)	1 = Metres
Empty Level (P105)	3.5m
Span (P106)	2.8m

Programming is now complete, and the unit can be returned to the run mode, press **CANCEL** until **Run Mode?** Is displayed on the LCD press **ENTER**, and the Ultra 4 will return to the **Run Mode**.

Important Notice

If relay setpoints do not meet the exact requirements of the application, they can be modified to suit by pressing ENTER when, “For More Options Hit Enter”, is displayed, and entering new values to relay setpoints as required. Alternatively, the relevant relay setpoint can be accessed either by the main menu system or directly via parameter number and changed as necessary.

Example 6 Reservoir Control (pump up)

A reservoir is typically used to temporarily hold liquid, and when the level reaches a specific low point, the reservoir is pumped up.

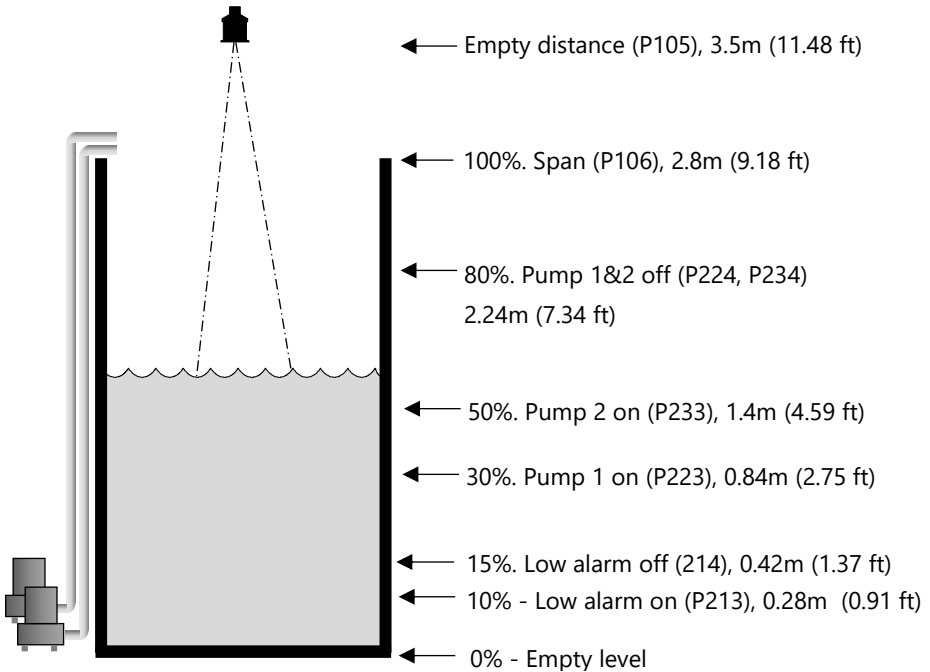

In this example, there are two pumps, which will be set to alternate duty assist, so they come on alternately. Pump 1 is to be set to relay 2, pump 2 to relay 3, and the low-level alarm to relay 1. This will operate as follows: During normal operation, **pump 1** will come on at 1.4m (4.59 ft) and pump up to 2.24m (7.34 ft). The setpoints are then shifted to **pump 2**, which will come on **first next time**.

During peak periods, when **pump 1** cannot cope, **pump 1** will come on at 1.4m (4.59 ft) and **pump 2** will come on at 0.84m (2.75 ft) and pump up to 2.24m (7.34 ft). The setpoints are then shifted to **pump 2**, which will come on **first next time**. If both pumps cannot cope, and the level drops to 0.28m (0.91 ft), then the alarm relay (relay 1) will come on and go off when the level rises to 0.42m (1.37 ft). This will indicate insufficient capacity of the pumps. The display will show the level in the sump and the mA output will

be representative of level where 4mA = empty level (0%) and 20mA = 2.8m (9.18 ft) (100%).

To program the Ultra 4 for **Example 6 Reservoir Control (pump up)** by using the **Quick Setup** menu proceed as follows. If required access the **Program Mode** and key in the **passcode** 1997 and press **ENTER**

Using the 'right arrow key, go to **Quick Setup** menu press **ENTER** and as prompted, by the questions, select the relevant option and **ENTER**.

QUESTION	OPTION
Level/Pump Up or Down	2 = Pump Up
No. of Pumps	2 = 2 Pumps
Pump Duty	3 =Alt Duty Assist
Pump No. 1	1 = Set to relay 2
Pump No. 2	2 = Set to relay 3
No. of alarms	1 = 1 alarm
Type Alarm 1	2 = Low Alarm
Alarm No. 1	The unit knows that only relay 1 is available and so will automatically set alarm 1 to Relay 1
Xducer (P101)	2 = dB6
Measurement units (P104)	1 = Metres
Empty Level (P105)	3.5m
Span (P106)	2.8m

Programming is now complete, and the unit can be returned to the run mode, press **CANCEL** until **Run Mode?** Is displayed on the LCD press **ENTER**, and the Ultra 4 will return to the **Run Mode**.

Important Notice

If relay setpoints do not meet the exact requirements of the application, they can be modified to suit by pressing ENTER when, "For More Options Hit Enter", is displayed, and entering new values to relay setpoints as required. Alternatively, the relevant relay setpoint can be accessed either by the main menu system or directly via parameter number and changed as necessary.

CHAPTER 7 FLOW

When Ultra Wizard = 3 Flow

This quick set-up guide shows you how to get up and running within a few minutes of installing your **Flow 3**.

Before proceeding ensure that the **Ultra Wizard = 3 Flow** (Flow 3). For further details, see [Chapter 4 Ultra Wizard](#).

Enter Program Mode

First you need to go from run mode into program mode. Assuming the passcode is the default 1997, then you should enter this.



Pass Code * * * *

This will appear on the display of the unit, before pressing Enter.

Choose Quick Setup

Now you need to go into the quick setup. You will see on the display the words 'Ultra Wizard', press the 'right hand' arrow key and this will take you to the 'Quick Setup' menu option. Try pressing either of the two arrow keys to see some more menu options, but return to Quick Setup, and press



This takes you to the 'Quick Setup Menu.'



This takes you to the common applications menu, and several options will appear on the display.

Choose Your Application

There are five categories of **Primary Measuring Device**, which are all described in this chapter. They are **exponential, BS3860 flumes, BS3860 weirs, special and universal**. Calculations for flow can be performed using absolute or ratiometric calculations. The answer will be the same, the choice of calculation method being limited to the amount of information available, with regards to the primary measuring device. For ratiometric calculation it is normally sufficient to know the maximum flow at maximum head for the device in question. All types of primary measuring devices can be set up with a choice of alarms.

If you want to set-up a basic **exponential device**, as described in the following **example 1**, then choose 1. You then need to select the **primary measuring device** for your application from the following available options: **suppressed rectangular weir, Cipolletti (trapezoidal) weir, Venturi flume, Parshall flume, Leopold Lagco flume, V notch weir** or **other**, for any other type of exponential device.

To set-up an application for a **BS3680 flume**, as described in the following **example 2**, then choose 2. You then need to select the **primary measuring device** for your application from the following available options: **rectangular flume with or without hump, U-throated flume with or without hump**.

To set-up an application for a **BS3680 weir**, as described in the following **example 3**, then choose 3. You then need to select the **primary measuring device** for your application from the following available options: **rectangular weir, V notch full 90° (90degrees), V notch half 90° (53 degree 8 minutes)** or a **V notch quarter 90° (28 degree 4 minutes)**.

To set-up an application for a device contained in **special**, choose 5. You then need to select the **primary measuring device** for your application from the following available options: **Palmer Bowlus flume, H-flume** or a **V notch**, other than BS3680.

For devices, which do not match any of the above devices the application can be setup using a **universal flow calculation**, to select this option choose 6. You then need to select the **primary measuring device** for your application from the following available options: **linear flow** or **curved flow**. Once you have chosen your application you will be asked a series of questions which are answered by choosing the appropriate option as detailed in the flow chart below. Once all the questions have been answered you will be prompted to provide further information, as detailed in the tables below, to complete the programming of the unit.

Quick Setup Menu

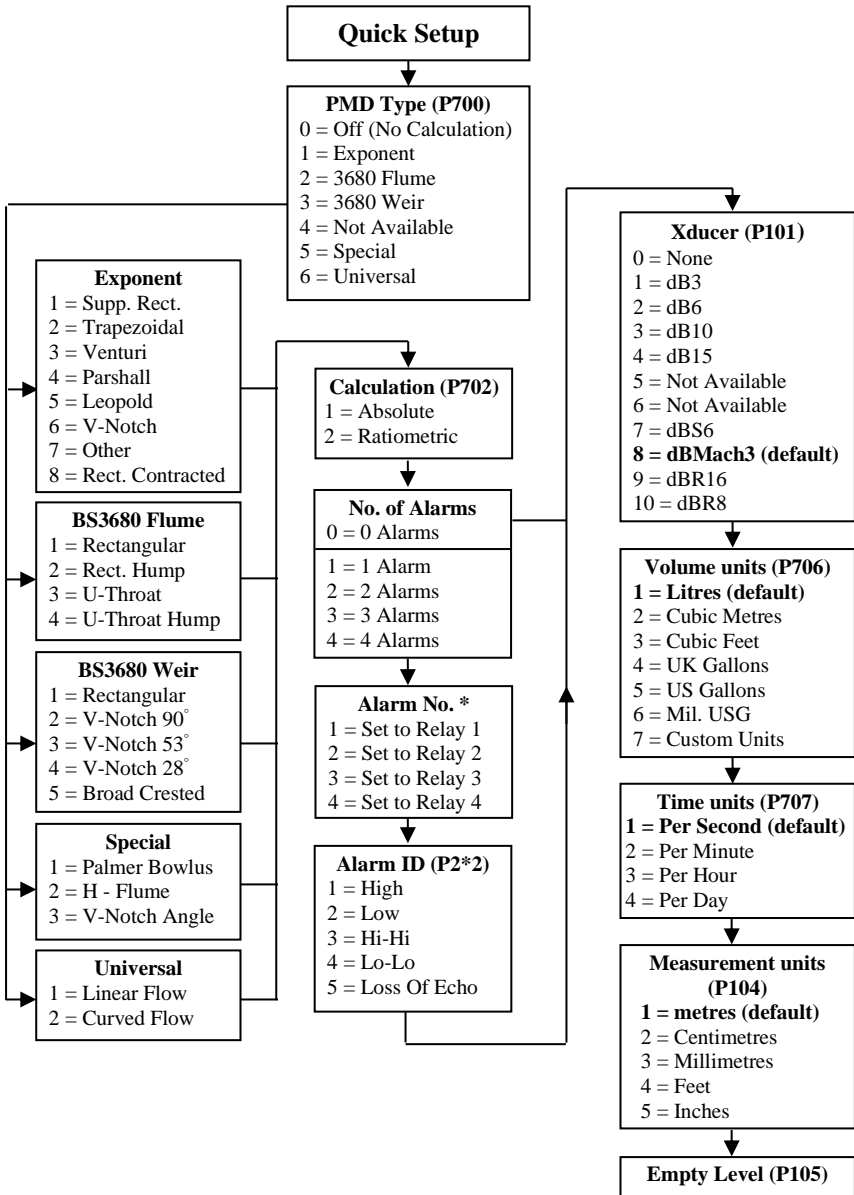

Quick Setup Flow Continued:

PARAMETER	DEFAULT	DESCRIPTION
P703 Minimum Head	0.000m	Distance from empty point (P105) to zero flow.
P704 Max Head	2.425m	Distance from zero flow to max flow. It should be noted that any change to P704 updates P106 Span, and vice versa.
P824 Totaliser Enable	1 = On	Enables the flow totaliser, P820, options are 0=Off, 1=On . Note this totaliser can be viewed during run mode by pressing the down arrow key. It can be reset but only whilst in program mode.
P823 Totaliser multiplier	7 = *1	Sets the factor by which the calculated volume will be divided or multiplied by before being displayed. 1 = /1,000,000 2 = /1,00,000 3 = /10,000 4 = /1,000 5 = /100 6 = /10 7 = *1 8 = *10 9 = *100 10 = *1,000 11 = *10,000 12 = *100,000 13 = *1,000,000

The remaining parameters required to finalise the setup of your application will follow on immediately from the above. These parameters relate to details required to carry out the calculation for flow and will be dependent on the Primary Measuring Device chosen and the method of calculation chosen, please enter values for the parameters concerned as requested.

PARAMETER	DEFAULT	DESCRIPTION
P705 Max flow	0.00	When requested enter the known maximum flow rate, in units of volume (P706) and Time (P707) which occurs at maximum head (P704)
P710 Dimension A	0	When requested, enter, in measurement units (P104) the required dimension.
P711 Dimension B	0	When requested, enter, in measurement units (P104) the required dimension.
P712 Dimension C	0	When requested, enter, in measurement units (P104) the required dimension.
P713 Dimension D	0	When requested, enter, in measurement units (P104) the required dimension.
P717 Exponent	Dependent on chosen PMD	Where available the unit will automatically enter the default exponent value for the PMD chosen, but this can be changed if required. When P700 = 7 (Other), enter the exponent value as defined by the manufacturer of the PMD.
P718 K Factor		Enter the 'K' factor for the PMD. Obtained from the manufacturer's specifications
P843 Aux Line 2	0 = None	Allows another variable to be shown in an auxiliary display line, such as the resettable totaliser.

Saving Parameters.... Please Wait

Important Notice

To view auxiliary information on the Big Screen in run mode, please program aux line 1 to view this information.

For More Options Hit Enter

PARAMETER	DEFAULT	DESCRIPTION
P213 / P214 Relay 1 ON/OFF setpoints	Depends on application	Either Alarm / Level control. Depends on application.
P223 / P224 Relay 2 ON/OFF setpoints	Depends on application	Either Alarm or Level control. Depends on application.
P233 / P234 Relay 3 ON/OFF setpoints	Depends on application	Either Alarm or Level control. Depends on application.
P234 / P244 Relay 4 ON/OFF setpoints	Depends on application	Either Alarm or Level control. Depends on application.
P708 Flow Decimal	2	Sets the number of decimal points required in the flow rate display.
P709 Flow cut off	5%	Enter, as a percentage maximum flow. The minimum flow rate to be added to the totaliser.
P830 mA Out range	2 = 4 -20mA	What the mA output uses for the range. 0= Off, 1= 0 to 20 mA, 2= 4 to 20 mA (Default) , 3= 20 to 0 mA, 4= 20 to 4 mA.
P870 Fill Damping	10m/min	Rate of maximum fill rate (set above the actual fill rate of the vessel)
P871 Empty Damping	10m/min	Rate of maximum empty rate (set above the actual empty rate of the vessel)





Relay Setpoints Table

The default values used for determining the **relay setpoints**, when setting **Alarm** relays, via the **Quick Setup** menu are entered as a % of span and are as follows.

RELAY FUNCTION	RELAY ID	ON SETPOINT	OFF SETPOINT
Alarm	HiHi	90%	85%
Alarm	High	85%	80%
Alarm	Low	10%	15%
Alarm	LoLo	5%	10%

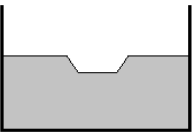
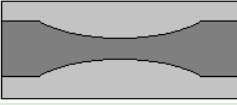
Exponential Devices

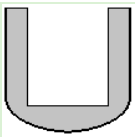
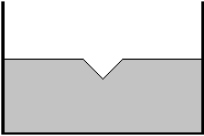
If the primary measuring device is a simple exponential device, then an exponent value is required. The Ultra 4 will automatically enter the exponent value for the device chosen as detailed in the table below.

EXPONENT TYPE	PMD SHAPE EXAMPLE	EXPONENT (P717)
Suppressed Rectangular Weir (Without end contractions)		1.50, automatically set by the unit.
Cipolletti (Trapezoidal) Weir		1.50, automatically set by the unit.
Venturi Flume		1.50, automatically set by the unit.
Parshall Flume		Automatically calculated according to the throat size.
Leopold Lagco Flume		1.55
V-Notch Weir		2.50
Other	As per manufacturer	Value to be set as required.
Contracted Rectangular Weir (With end contractions)		1.50

Point of Measurement

The transducer must be above the **maximum head P704** by at least the near **blanking distance P107**.

For **Suppressed/Contracted Rectangular, Trapezoidal and V-notch**, weirs, the head is measured **upstream** at a minimum distance of **3 times maximum head** from the weir plate to ensure the surface of the liquid is not affected by turbulence or drawdown. (See DRWG. 1)

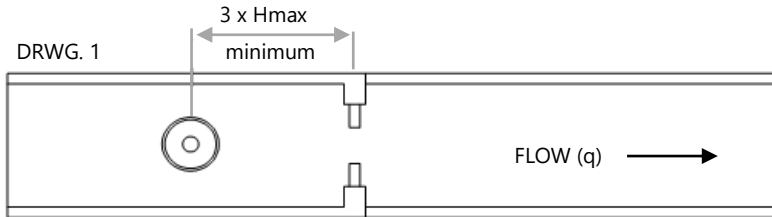

In the case of a **Venturi** flume the point of measurement should be **150 mm upstream** from the beginning of the **converging section** and for a **Parshall** flume **2/3 the length of the converging section** upstream of the **throat** section. (See DRWG 2 and 3).

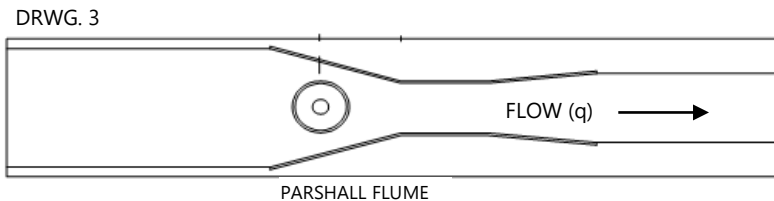
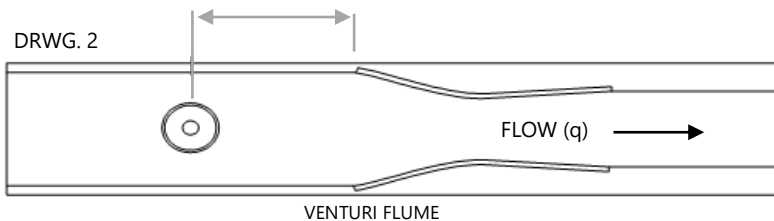

For a **Leopold Lagco** flume the head is measured at a point **upstream** of the beginning of the converging section as detailed in the table below. (See DRWG 4).

FLUME SIZE		POINT OF MEASUREMENT	
mm	inches	mm	inches
100 - 305	4 – 12	25	1.0
380	15	32	1.3
455	18	38	1.5
530	21	44	1.8
610	24	51	2.1
760	30	64	2.5
915	36	76	3.0
1065	42	89	3.5
1220	48	102	4.0
1370	54	114	4.5
1520	60	127	5.0
1675	66	140	5.5
1830	72	152	6.0

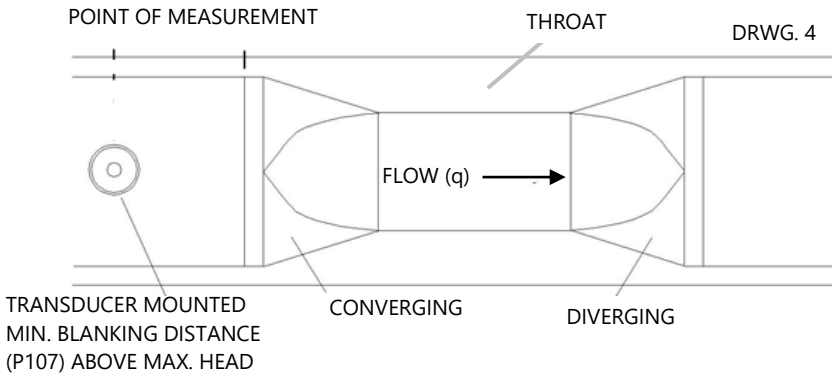

When any **Other** device is chosen, please consult the manufacturer of the device for details of where the point of measurement should be located but ensure that it is chosen such that the surface of the liquid is not affected by turbulence or drawdown.

Calculations

Absolute

If the flow calculation is to be absolute $P702 = 1$ the flow will be calculated using the formula (s) as follows:

EXPONENT TYPE	FORMULA	EXPONENT	K FACTOR
Suppressed Rectangular Weir (Without end contractions)	$Q = KLh^*$ Where: Q =Flow K =K Factor L =Crest length of weir h =head $*$ =exponent	1.50 Automatically selected by the Ultra 4	Automatically calculated, dependent on measurement, flow and time units chosen.
Cipolletti (Trapezoidal Weir)	$Q = KLh^*$ Where: Q =Flow K =K Factor L =Crest length of weir h =head $*$ =exponent	1.50 Automatically selected by the Ultra 4	Automatically calculated, dependent on measurement, flow and time units chosen
Venturi Flume	$Q = Kh^*$ Where: Q =Flow K =K Factor h =head $*$ =exponent	1.50 Automatically selected by the Ultra 4	Enter value of K Factor (P718) as required
Parshall Flume	$Q = Kh^*$ Where: Q =Flow K =K Factor h =head $*$ =exponent	Automatically calculated, dependent on throat size (P719)	Automatically calculated, dependent on measurement, flow and time units chosen
Leopold Lagco Flume	$Q = KD^{0.0953}h^x$ Where: Q = Flow K =K factor D =pipe diameter h =head $*$ =exponent	1.55 Automatically selected by the Ultra 4	Automatically calculated, dependent on measurement, flow and time units chosen

EXPONENT TYPE	FORMULA	EXPONENT	K FACTOR
V-Notch Weir	$Q = Kh^x$ Where: Q =Flow K=K factor h=head *=exponent	2.50 Automatically selected by the Ultra 4	Automatically calculated, dependent on measurement flow and time units chosen.
Other	$Q = Kh^x$	Enter value as required	Enter value as required
Contracted Rectangular Weir (With end contractions)	$Q = K(L - 0.2 * h)h^x$ Where: Q =Flow K= K factor L=crest length of weir h=head x= exponent	1.50 Automatically selected by the Ultra 4	Automatically calculated, dependent on measurement flow and time units chosen.

Ratiometric

If the flow calculation is to be **ratiometric P702 = 2** the flow will be calculated using the formula: $q = q_{cal} (h/h_{cal})^x$

Where:

q = flowrate

q_{cal} = **flowrate** at **maximum** head (**705**)

h = head

h_{cal} = **maximum head** (**P704**)

x = exponent (determined as in absolute calculation above)

Example 1 'V' Notch Weir

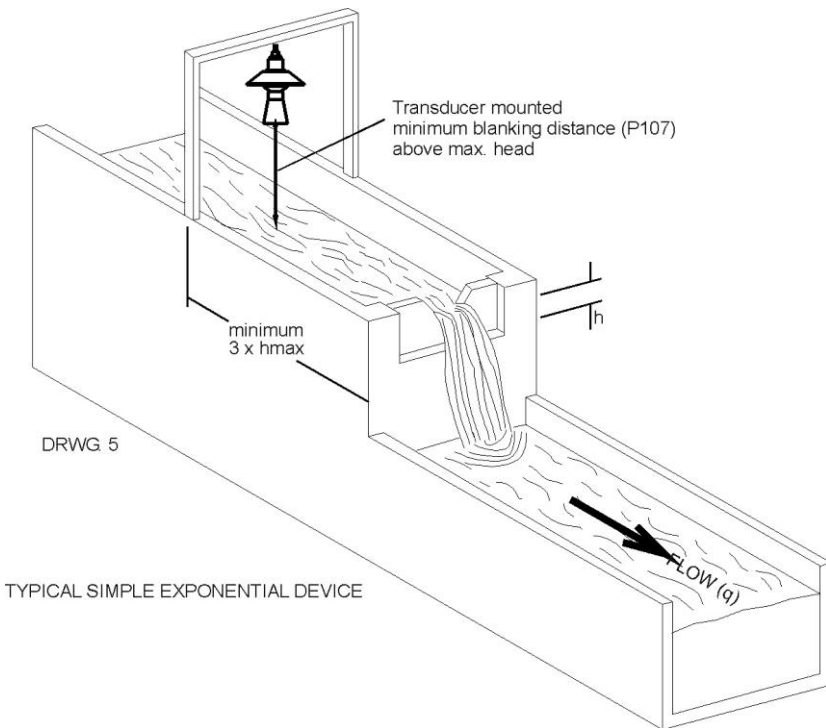

In this example, it is required to calculate the flow through a Simple Exponential Device, which on this occasion is a V-Notch Weir. Ratiometric calculation will be used, to use the customers declared maximum flow, there is no requirement for alarms and the flow rate is to be displayed in litres/second. The totaliser is to record the flow in cubic metres but is not to be displayed during RUN.

The distance from the end of the transducer horn (dB Mach 3) to **zero** flow (**P105**) is 1 metre and **max head (P704)** is 0.4 metres, **maximum flow (P705)** is known to be 96.5 litres/second.

To program the Ultra 4 for **Example 1 V-Notch Weir** by using the **Quick Setup** menu proceed as follows. If required access the **Program Mode**, key in the **passcode** 1997 and press **ENTER**

Using the 'right' arrow key, go to the **Quick Setup** menu press **ENTER** and as prompted, by the questions, select the relevant option and press **ENTER**.

QUESTION	OPTION
PMD Type	1 = Exponent
Exponent	6 = V-Notch
Calculation	2 = Ratiometric
No. of alarms	0 = No alarms
Xducer	1 = dB Mach3
Volume units	1 = Litres
Time units	1 = Per second
Measurement units	1 = metres
Empty Level	1.00 metres
Minimum head	0.00 metres
Maximum head	0.40 metres
Totaliser enable	1 = On
Totaliser (R)	0 = No
Totaliser multiplier	7 = *1
Max flow	96.5
Aux Line	0 = None

Programming is now complete, and the unit can now be returned to the run mode, press **CANCEL** until **Run Mode?** Is displayed on the LCD press **ENTER**, and the Ultra 4 will return to **Run Mode**.

BS3680 Flumes (P700 = 2)*Point of Measurement*

The transducer must be above the **maximum head P704** by at least the near **blanking distance P107**.

For a **Rectangular** and **U-throated** flume, the head is measured at **3 to 4 times** the **maximum head upstream** from the beginning of the **converging section**, to ensure the surface of the liquid is not affected by turbulence. (See DRWG 6)

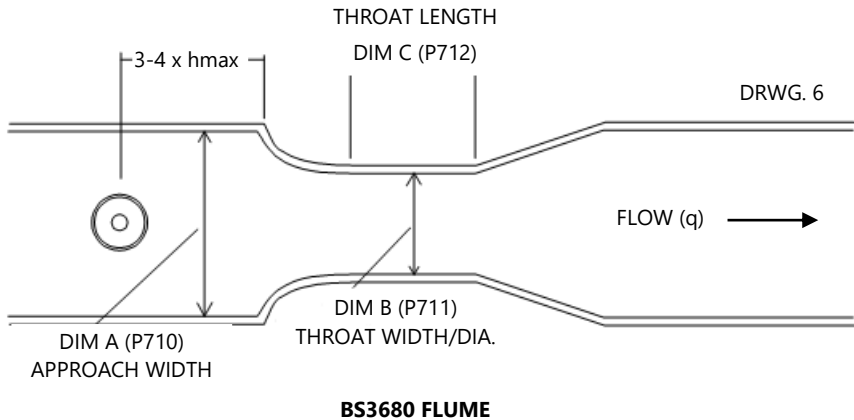

Rectangular Flume Calculations

Absolute

If the flow calculation is to be **absolute P702 = 1** the flow will be calculated using the formula: $q = (2/3)^{1.5}gn^{0.5}C_sC_vC_dbh^{1.5}$

Where:

q = flowrate

gn = gravitational acceleration (nominal value = 980.66 cm/s²)

C_s = **shape coefficient** (value = 1)

C_v = **velocity coefficient** calculated by Ultra 4 (P721)

C_d = **discharge coefficient** calculated by Ultra 4 (P722)

b = **throat width P711**

h = head

Ratiometric

If the flow calculation is to be **ratiometric P702 = 2** the flow will be calculated using the formula: $q = q_{cal}(C_v/C_{vcal})(C_d/C_{dcal})(h/h_{cal})^{1.5}$

Where:

q = flowrate

q_{cal} = **flowrate at maximum head P705**

C_v = **velocity coefficient** calculated by Ultra 4 (P721)

C_{vcal} = velocity coefficient at maximum head

C_d = **discharge coefficient** calculated by Ultra 4 (P722)

C_{dcal} = discharge coefficient at maximum head

h = head

h_{cal} = **maximum head P704**

U-Throated Flume Calculations

Absolute

If the flow calculation is to be **absolute P702 = 1** the flow will be calculated using the formula: $q = (2/3)^{1.5} g_n^{0.5} C_u C_v C_d b h^{1.5}$

Where:

q = flowrate

g_n = gravitational acceleration, (nominal value = 980.66 cm/s²)

h = head

C_u = **shape coefficient** calculated by Ultra 4 (P724)

C_v = **velocity coefficient** calculated by Ultra 4 (P721)

C_d = **discharge coefficient** calculated by Ultra 4 (P722)

b = **throat width P711**

Ratiometric

If the flow calculation is to be **ratiometric P702 = 2** the flow will be calculated using the formula:

$$q = q_{cal} (C_v/C_{vcal}) (C_d/C_{dcal}) (C_u/C_{ucal}) (h/h_{cal})^{1.5}$$

Where:

q = flowrate

q_{cal} = **flowrate at maximum head P705**

C_v = **velocity coefficient** calculated by Ultra 4 (P721)

C_{vcal} = velocity coefficient at maximum head

C_d = **discharge coefficient** calculated by Ultra 4 (P722)

C_{dcal} = discharge coefficient at maximum head

C_u = **shape coefficient P724**

C_{ucal} = shape coefficient at maximum head

h = head **h_{cal}** = **maximum head P704**

Example 2 BS3680 U-Throated Flume

In this example, it is required to calculate to BS3680 the flow through a U-Throated Flume without any hump. Absolute calculation will be used, and there is a requirement for an alarm to indicate a low flow condition which will be set to relay 1. The flow rate is to be displayed in cubic meters/hour and the totaliser is also to record the flow in cubic metres, the resettable totaliser is to be displayed during RUN.

The distance from the end of the transducer horn (dB Mach 3) to **zero** flow (**P105**) is 1 metre and **max head (P704)** is 0.4 metres, **maximum flow (P705)** which will be calculated by the **Ultra 4** as 725.171 cubic metres/hour.

The dimensions of the flume are as follows:

- Approach Channel diameter (Dim "A") P710** = 0.7 m (2.29 ft)
- Throat diameter (Dim "B") P711** = 0.5 m (1.64 ft)
- Throat length (Dim "C") P712** = 1.0m (3.28 ft)

To program the Ultra 4 for **Example 2 BS3680 U-Throated Flume** by using the **Quick Setup** menu proceed as follows.

To program the Ultra 4 for **Example 2 BS3680 U-Throated Flume** by using the **Quick Setup** menu proceed as follows. If required access the **Program Mode**, key in the passcode 1997 and press **ENTER**. Using the 'right' arrow key, go to the **Quick Setup** menu press **ENTER** and as prompted, select the relevant option and press **ENTER**.

QUESTION	OPTION
PMD Type	2 = 3680 Flume
3680 Flumes	3 = U-Throat
Calculation	1 = Absolute
No. of alarms	1 = 1 Alarm
Type alarm 1	2 = Low
Alarm No.1	1 = Set to relay 1
Transducer	8 = dB Mach3
Volume units	2 = Cubic metres
Time Units	4 = Per hour
Measurement units	1 = Metres
Empty level	1.00m
Minimum head	0.00m
Maximum head	0.40m
Totaliser enabled	1 = On
Totaliser multiplier	7 = *1
Approach dia. (Dim A)	0.70m
Throat dia. (Dim B)	0.50m
Throat length (Dim C)	1.00m
Aux Line 2	13 = Tot R

Programming is now complete, and the unit can now be returned to the run mode, press **CANCEL** until **Run Mode?** Is displayed on the LCD press **ENTER**, and the Ultra 4 will return to **Run Mode**.

Important Notice

If relay setpoints do not meet the exact requirements of the application, they can be modified to suit by pressing ENTER when, "For More Options Hit Enter", is displayed, and entering new values to relay setpoints as required. Alternatively, the relevant relay setpoint can be accessed either by the main menu system or directly via parameter number and changed as necessary.

BS3680 Weirs (P700 = 3)

Point of Measurement

The transducer must be above the **maximum head P704** by at least the near **blanking distance P107**.

For a **Rectangular** and **V-notch** weir, the head is measured at a point 4 to 5 **times the maximum head upstream** from the weir plate, to ensure the surface of the liquid is not affected by turbulence or drawdown. (See DRWG 7)

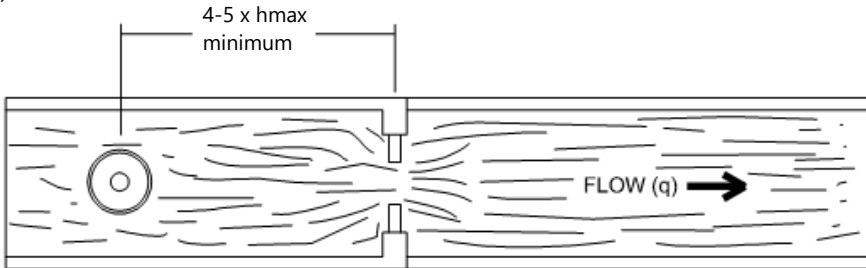

DRWG. 7

BS3680 WEIR

Rectangular Weir Calculations

Absolute

If the flow calculation is to be **absolute P702 = 1** the flow will be calculated using the formula: $q = C_e \frac{2}{3}(2gn)^{0.5} b_e h_e^{1.5}$

Where:

q = flowrate

Ce = **discharge coefficient** calculated by Ultra 4 (P723)

gn = gravitational acceleration (nominal value = 980.66 cm/s²)

be = effective approach width where **b** is **approach width (Dim "A") P710**

he = effective head

Ratiometric

If the flow calculation is to be **ratiometric P702 = 2** the flow will be calculated using the formula: $q = q_{cal} C_e / C_{ecal} (h_e / h_{ecal})^{1.5}$

Where:

q = flowrate

q_{cal} = **flowrate at maximum head P705**

C_e = **discharge coefficient** calculated by Ultra 4 (P723)

C_{ecal} = discharge coefficient at maximum head

h_e = effective head

h_{ecal} = effective head at maximum head

V-Notch Weir Calculations

Absolute

If the flow calculation is to be **absolute P702 = 1** the flow will be calculated using the formula: $q = C_e 8 / 15 \tan(\theta/2) (2gn)^{0.5} h^{2.5}$

Where:

q = flowrate

C_e = **discharge coefficient** calculated by the Ultra 4 (P723)

θ = V-notch angle

gn = gravitational acceleration (nominal value = 980.66 cm/s²)

h = head

The Ultra 4 pre-sets the angle (θ) on selection of the chosen device this angle is **90°** for a BS 3680 **full 90°V notch** weir, **53° 8 minutes** in the case of the BS3680 **half 90°V notch** weir and **28° 4 minutes** in the case of the BS3680 **quarter 90°V notch**.

Ratiometric

If the flow calculation is to be **ratiometric P702 = 2** the flow will be calculated using the formula: $q = q_{cal} C_e(h) / C_e(h_{cal}) (h / h_{cal})^{2.5}$

Where:

q = flowrate

q_{cal} = **flowrate at maximum head P705**

$C_e(h)$ = discharge coefficient for head

$C_e(h_{cal})$ = discharge coefficient for maximum head

h = head

h_{cal} = **maximum head P704**

Example 3 BS3680 Rectangular Weir

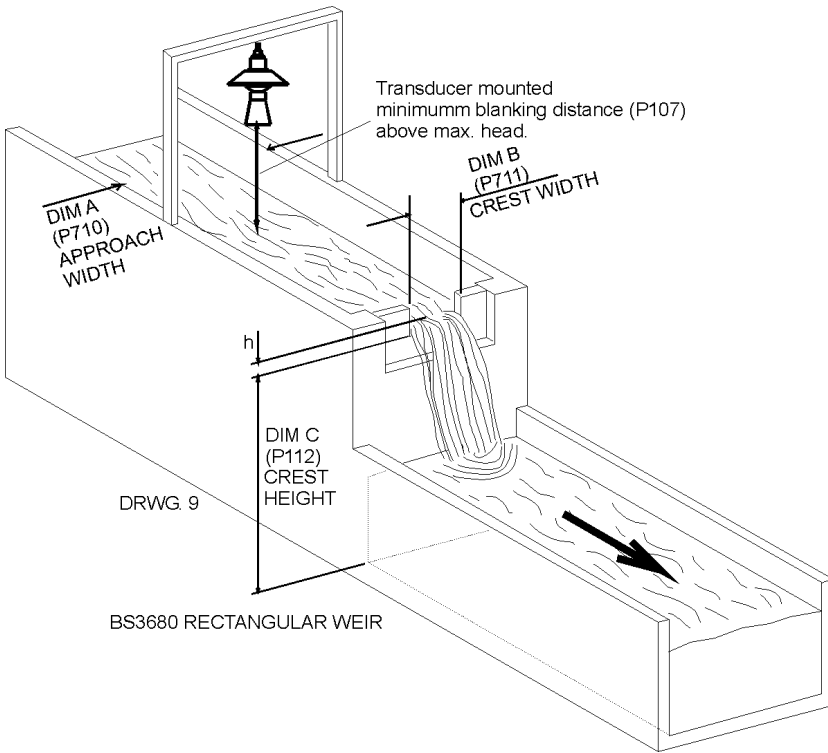

In this example, it is required to calculate to the flow through a BS3680 Rectangular weir. Absolute calculation will be used, and there is a requirement for an alarm to indicate a high flow condition to be set to relay 3. The flow rate is required to be displayed in litres/minute and the totaliser is to record the flow in cubic metres, the resettable totaliser is to be displayed during RUN.

The distance from the end of the transducer horn to **zero flow (P105)** is 1 metre and **max head (P704)** is 0.4 metres, **maximum flow (P705)**.

- Approach width (Dim "A") P710** = 0.5 m (1.64 ft)
- Crest width (Dim "B") P711** = 0.3 m (0.98 ft)
- Crest Height (Dim "C") P712** = 0.3 m (0.98 ft)

To program the Ultra 4 for **Example 3 BS3680 Weir** by using the **Quick Setup** menu proceed as follows. If required access the **Program Mode**, key in the **passcode** 1997 and press **ENTER**.

Using the 'right' arrow key, go to the **Quick Setup** menu press **ENTER** and as prompted, by the questions, select the relevant option and press **ENTER**.

QUESTION	OPTION
PMD Type	3 = 3680 Weir
3680 Weir	1 = Rectangular
Calculation	1 = Absolute
No. of alarms	1 = 1 Alarm
Type alarm 1	1 = High
Alarm No.1	1 = Set to relay 3
Transducer	8 = dB Mach3
Volume units	1 = Litres
Time Units	2 = Minute
Measurement units	1 = Metres
Empty level	1.00m
Minimum head	0.00m
Maximum head	0.40m
Totaliser enabled	1 = On
Totaliser multiplier	7 = 1000
Approach dia. (Dim A)	0.50m
Throat dia. (Dim B)	0.30m
Throat length (Dim C)	0.30m
Aux Line 2	13 = TotR

Programming is now complete, and the unit can now be returned to the run mode, press **CANCEL** until **Run Mode?** Is displayed on the LCD press **ENTER**, and the Ultra 4 will return to **Run Mode**.

Important Notice

If relay setpoints do not meet the exact requirements of the application, they can be modified to suit by pressing ENTER when, "For More Options Hit Enter", is displayed, and entering new values to relay setpoints as required. Alternatively, the relevant relay setpoint can be accessed either by the main menu system or directly via parameter number and changed as necessary.

BS3680 Rectangular Broad Crested Weir

Point of Measurement

The transducer must be above the **maximum head P704** by at least the near **blanking distance P107**.

The head is measured at a point 3 to 4 **times** the **maximum head upstream** from the weir crest, to ensure the surface of the liquid is not affected by turbulence or drawdown.

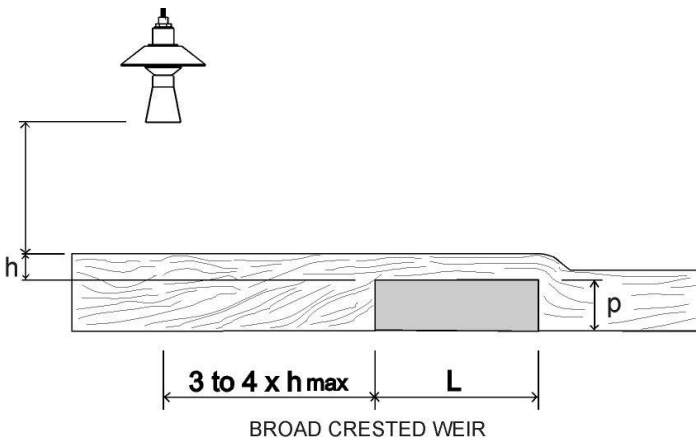

Rectangular Broad Crested Weir Calculations

Calculations

Absolute

If the flow calculation is to be **absolute P702 = 1** the flow will be calculated using the formula: $q = (2/3)^{1.5} C_e b (gh^3)^{0.5}$

Where:

q = flowrate

C_e = **discharge coefficient** calculated by Ultra 4 **P723**

b = approach width **P710**

g = gravitational acceleration (nominal value = 980.66 cm/s²)

h = head

Ratiometric

If the flow calculation is to be **ratiometric P702 = 2** the flow will be calculated using the formula: $q = q_{cal} C_e / C_{ecal} (h_e / h_{ecal})^{1.5}$

Where:

q = flowrate

q_{cal} = **flowrate at maximum head P705**

C_e = **discharge coefficient** calculated by Ultra 4 **P723**

C_{ecal} = discharge coefficient at maximum head

h_e = effective head

h_{ecal} = effective head at maximum head

Special Devices

Point of Measurement

The transducer must be above the **maximum head P704** by at least the near **blanking distance P107**.

In the case of a **Palmer Bowlus** flume the point of head measurement should be **half** the value of **Dim "A" P710 upstream** of the device.

For a **H-Flume** the head measurement is taken at a point **downstream** from the flume entrance as detailed in the table below:

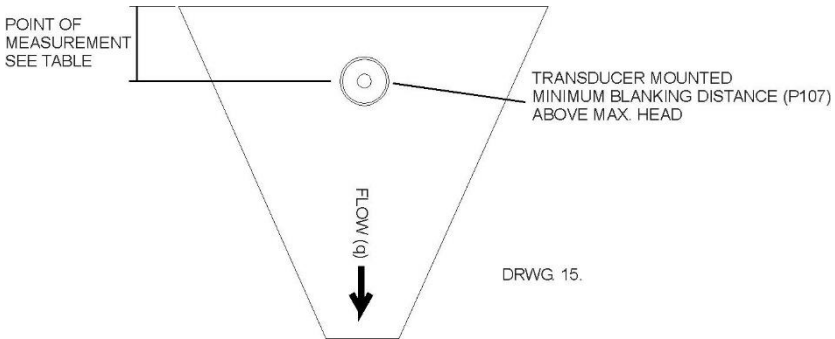

FLUME SIZE-DIM A (P710)		POINT OF MEASUREMENT	
cm	feet	cm	inches
15.25	0.5	4.7	1.88
23.00	0.75	6.7	2.69
30.05	1.0	9.1	3.63
45.70	1.5	13.5	5.378
61.00	2.0	17.9	7.19
76.20	2.5	22.5	9.00
91.45	3.0	27.2	10.88
137.15	4.5	40.5	16.19

V-notch angle weirs, the head is measured **upstream** of the weir plate at a minimum distance of **3 times maximum head** to ensure the surface of the liquid is not affected by turbulence or drawdown. See Exponential devices, above, for further details.

Palmer Bowlus and H-Flume Calculations

Absolute

If the flow calculation is to be **absolute P702 = 1** the flow will be calculated using the formula: $q = f(h)$

Where:

q = flowrate

f = is an 8th degree polynomial solution for h (head)

Ratiometric

If the flow calculation is to be ratiometric $P702 = 2$ the flow will be calculated using the formula: $q = q_{cal} f(h)/f(h_{cal})$

Where:

q = flowrate

q_{cal} = flowrate at maximum head P705

$f(h)$ = a polynomial solution for h (head)

$f(h_{cal})$ = a polynomial solution for h_{cal} (maximum head)

V-Notch Angle Weir (Non-BS 3680) Calculations

Absolute

If the flow calculation is to be absolute P702 = 1 the flow will be calculated using the formula: $q = C_e \frac{8}{15} \tan(\theta/2)(2gn)^{0.5}(h + kh)^{2.5}$

Where: q = flowrate

C_e = discharge coefficient calculated by Ultra 4 (P723)

θ = V-notch angle

gn = gravitational acceleration

h = head

kh = compensated head

Ratiometric

If the flow calculation is to be **ratiometric P702 = 2** the flow will be calculated using the formula: $q = q_{cal} (h + kh/h_{cal} + kh)^{2.5}$

Where: q = flowrate

q_{cal} = **flowrate at maximum head P705**

h = head

kh = compensated head

Universal Calculations (P700=6)

Point of Measurement

The transducer must be above the **maximum head P704** by at least the near **blanking distance P107**.

For all **Universal** calculation applications, the point at which the head is measured should be chosen such that the surface of the liquid is not affected by turbulence.

Absolute

If the flow calculation is to be absolute P702 = 1 the flow will be calculated using the formula: $q = q(h)$

Where: q = flowrate

q(h) = flowrate for head

The desired number of Breakpoints, (P730 - P793) are to be entered in pairs in values of head and corresponding flow. (Minimum of 2 pairs of Breakpoints is required).

CHAPTER 8 PARAMETER GUIDE

This chapter describes all the parameters in your Ultra 4, as they appear in the menu system.

Menu System

Shown below is a set of charts to show you how all the various functions and features can be found using the menu system.

For further details and a full description of all parameters refer to the **Parameter Listings and Descriptions** section of this chapter.

Top Level Menu

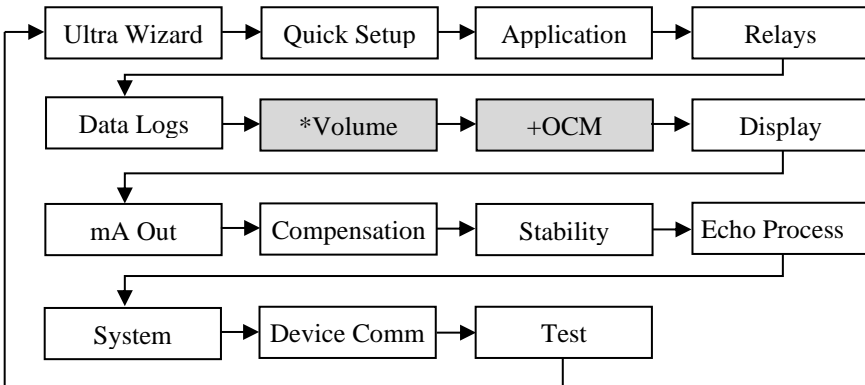

*This option becomes available when Ultra Wizard = Level/Volume.

+This option becomes available when Ultra Wizard = Flow.

Application Menu

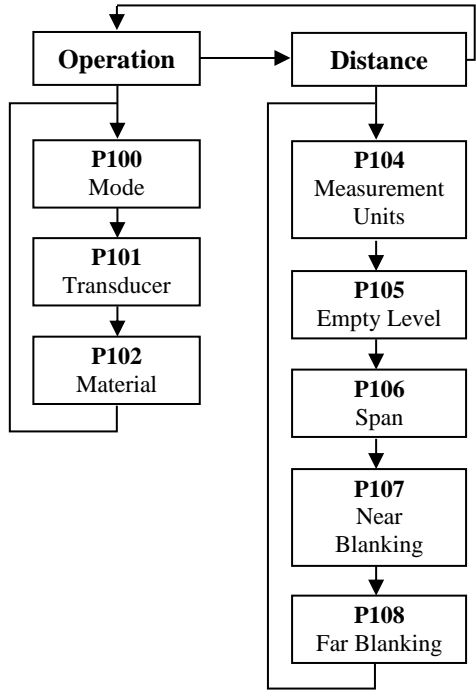

Relays Menu

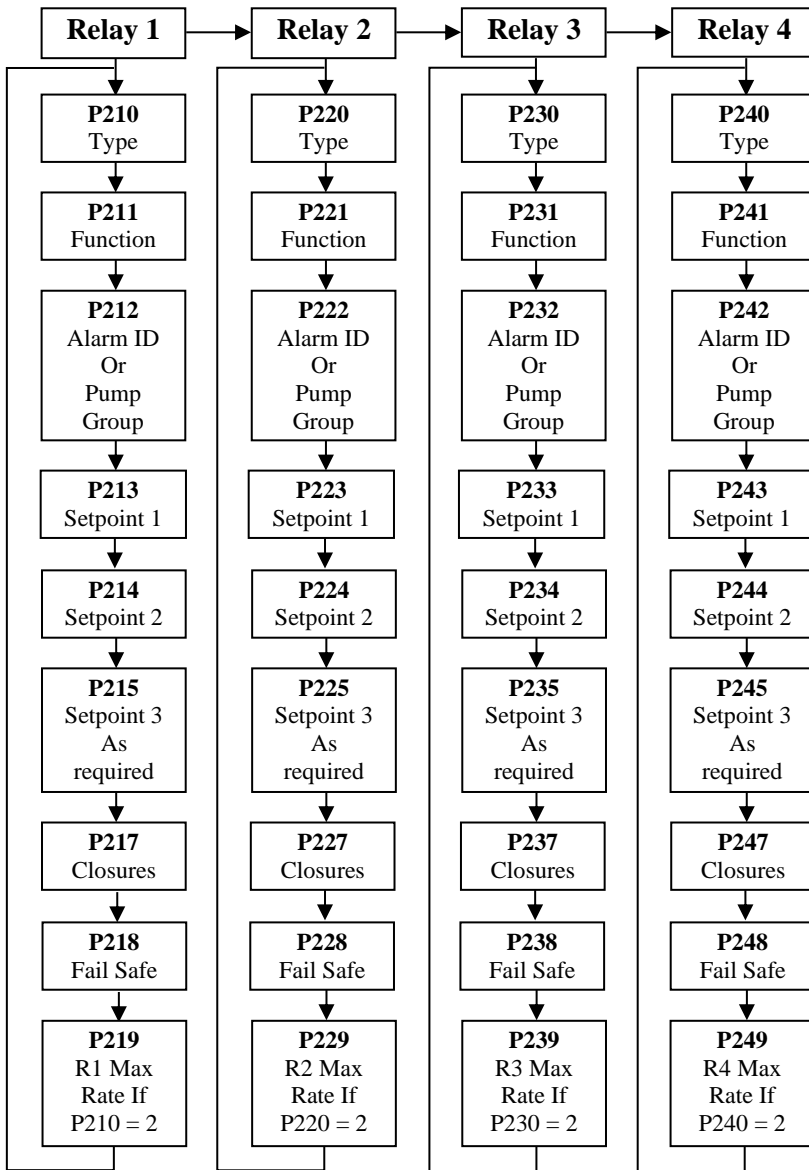

Data Logs Menu

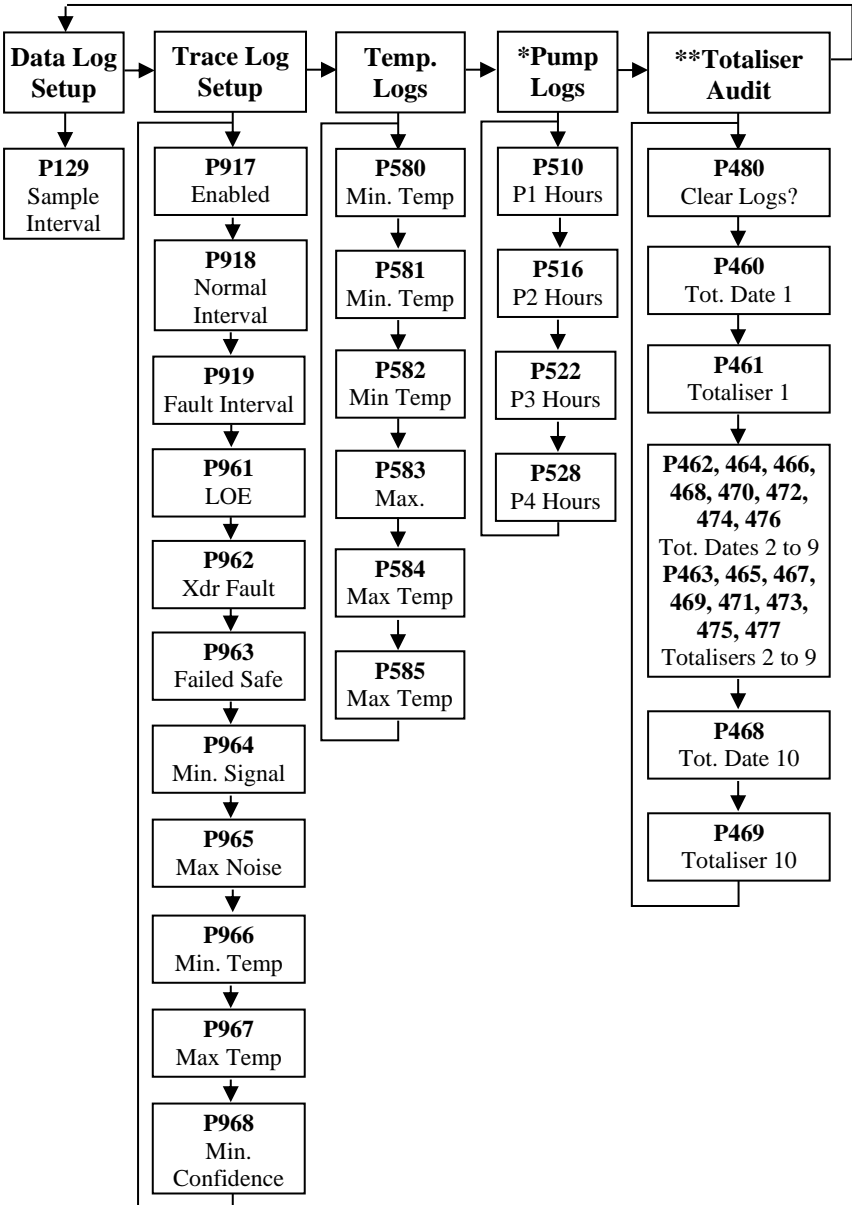

Volume: Available when Ultra Wizard = Volume

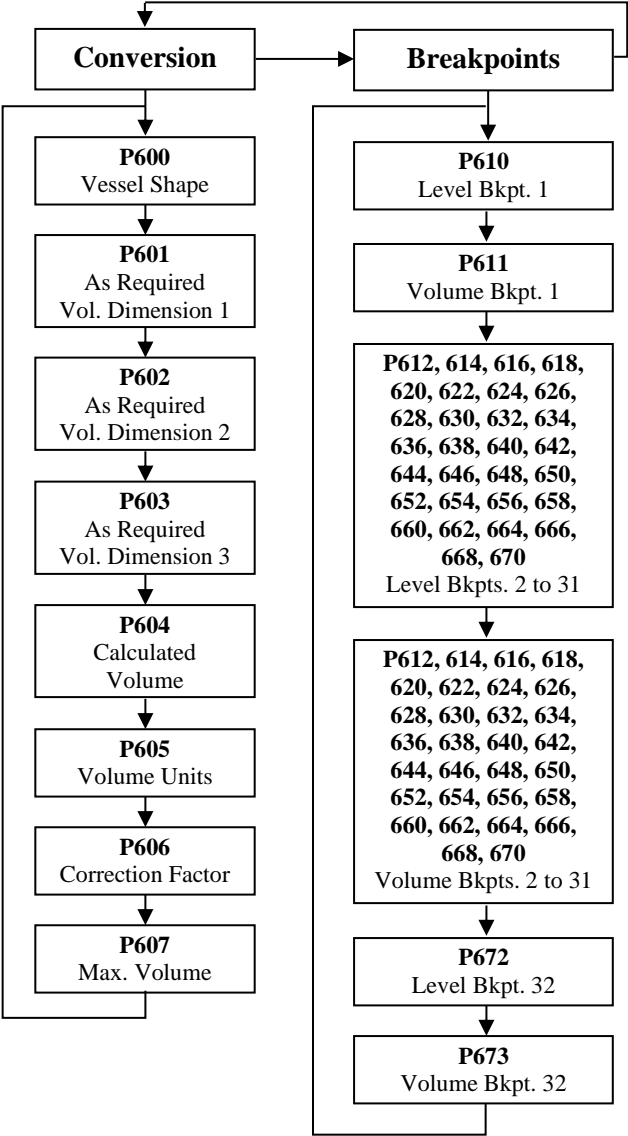

OCM: Available when Ultra Wizard = Flow

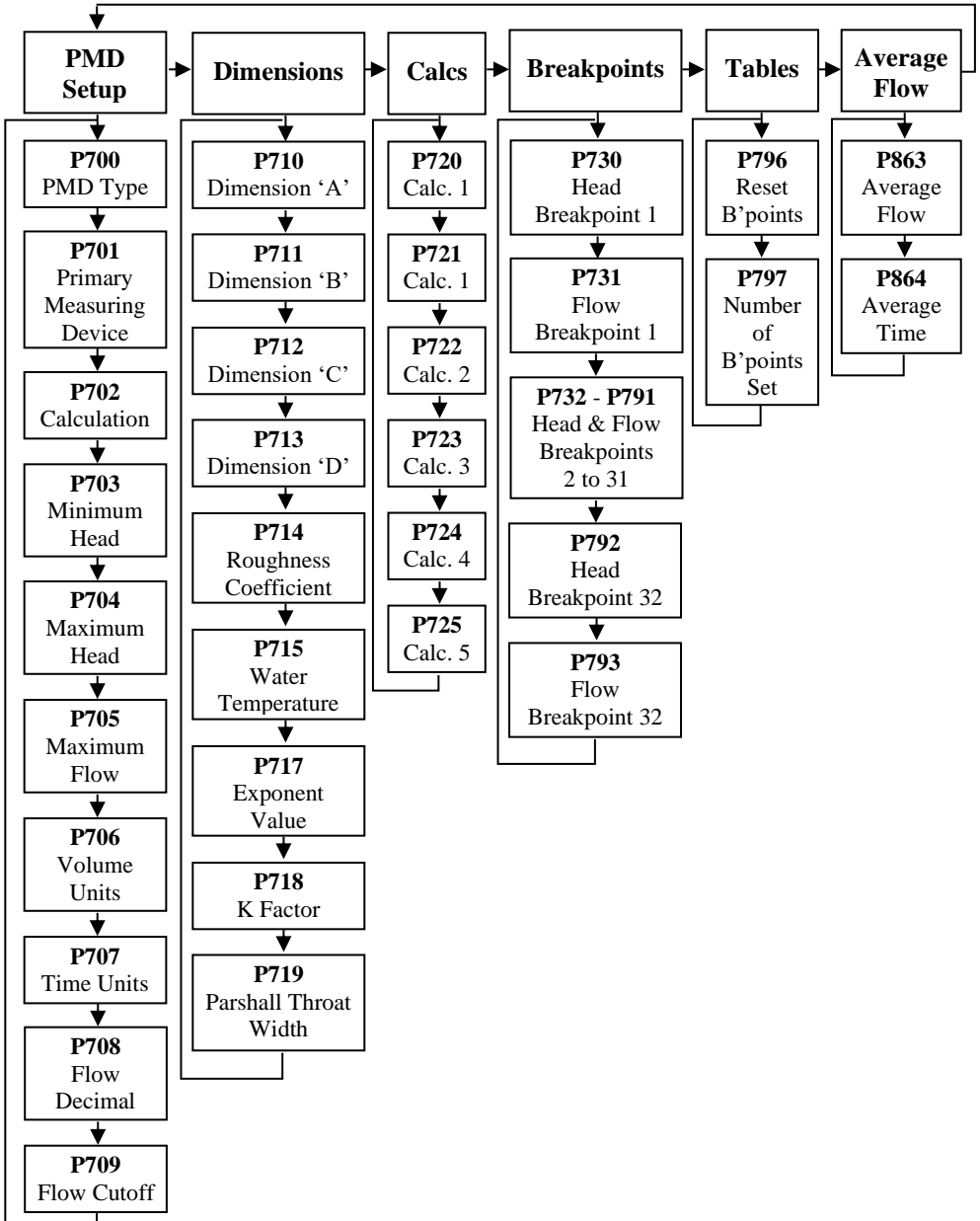

Display Menu

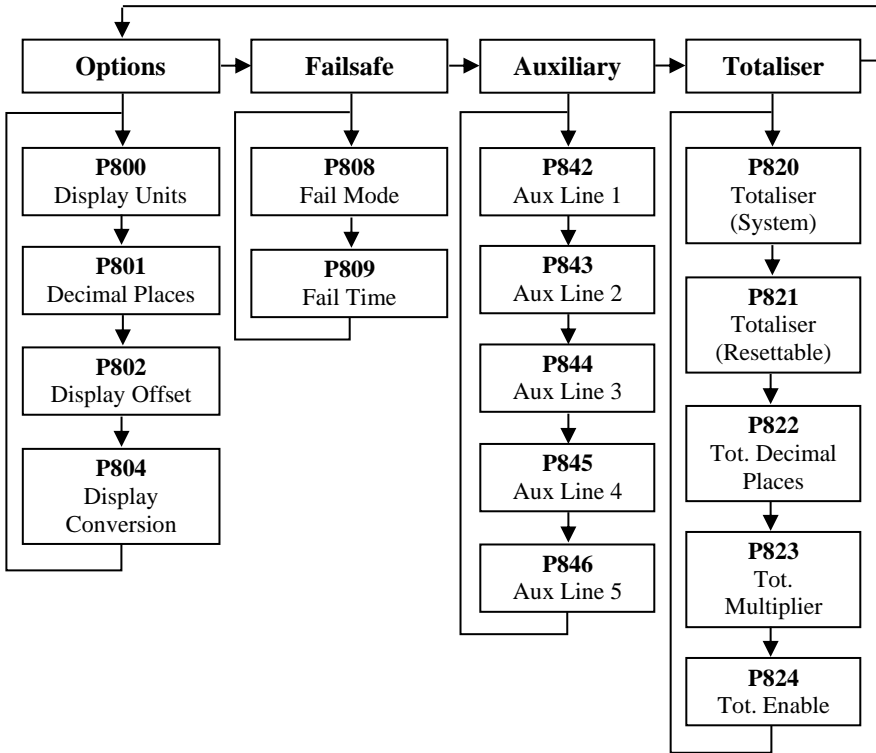

mA Output Menu

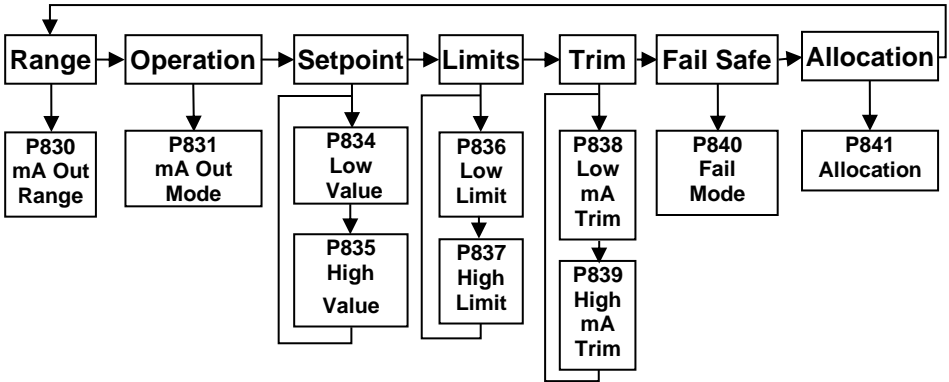

Compensation Menu

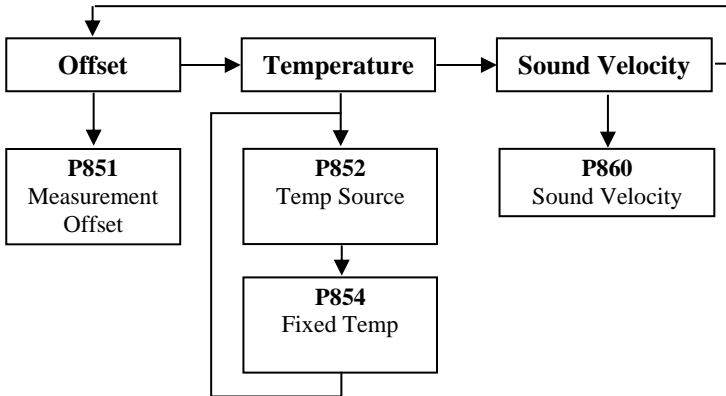

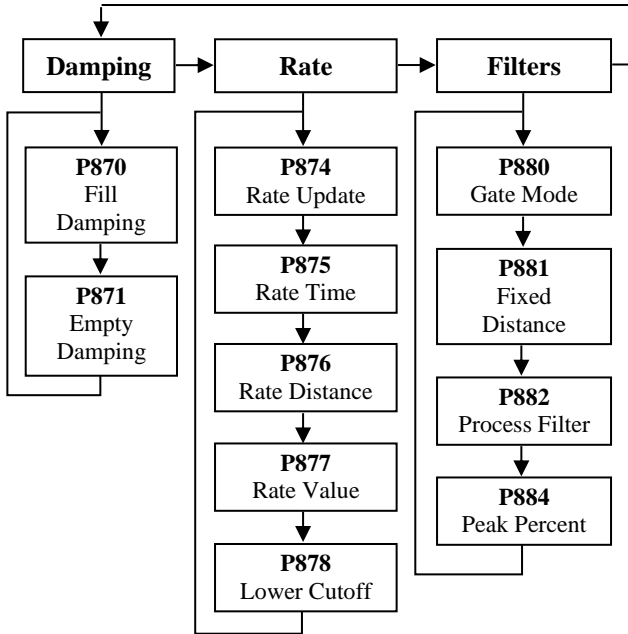
Stability Menu

Echo Processing Menu

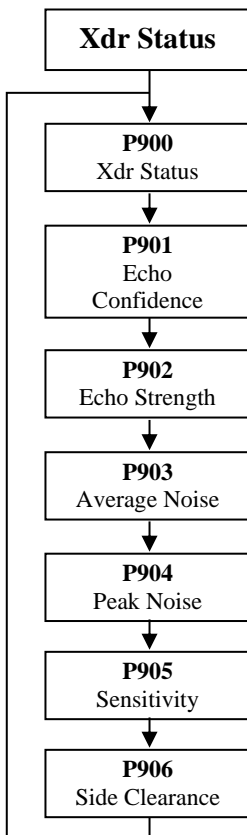

System Menu

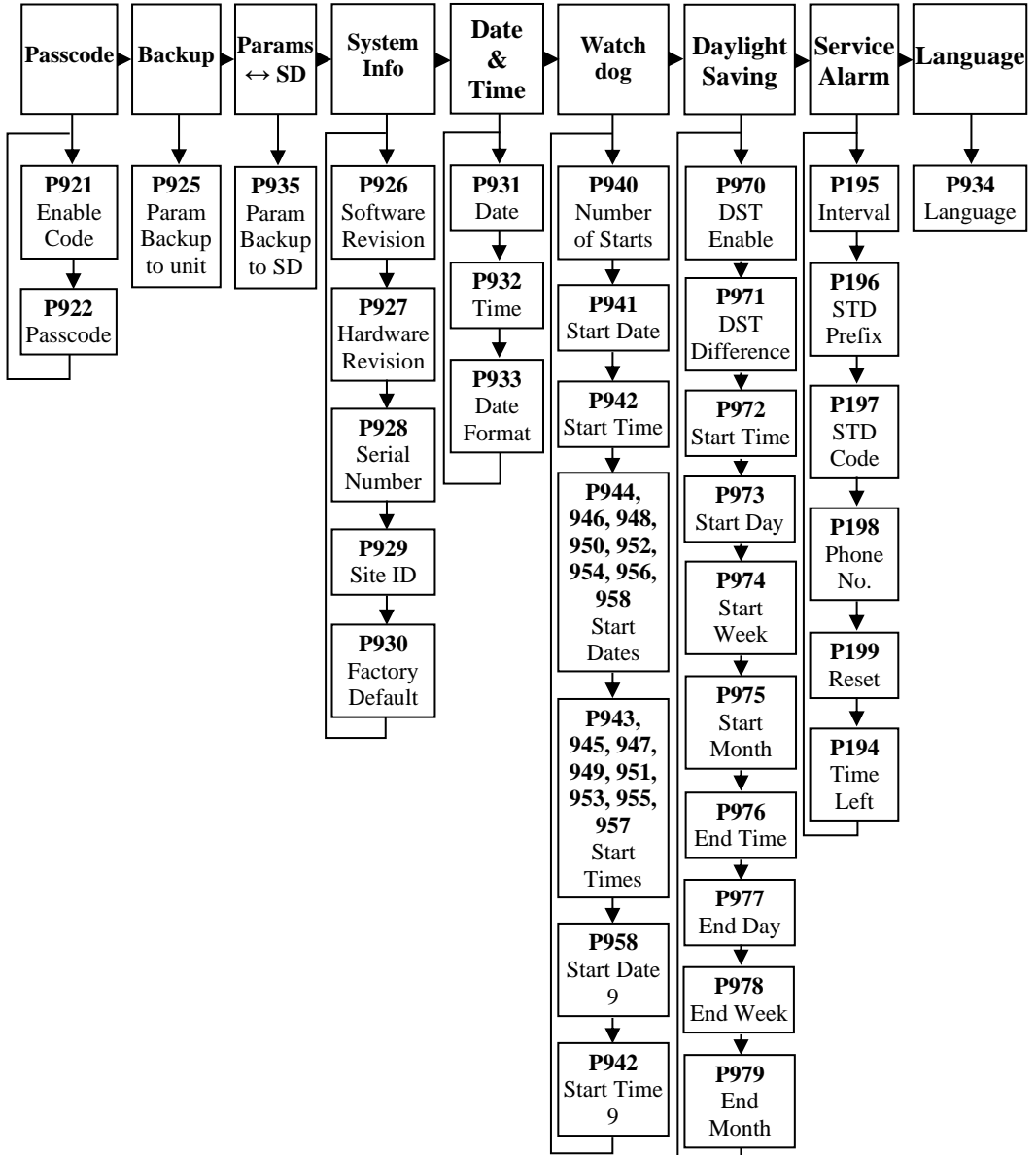

Device Comm Menu

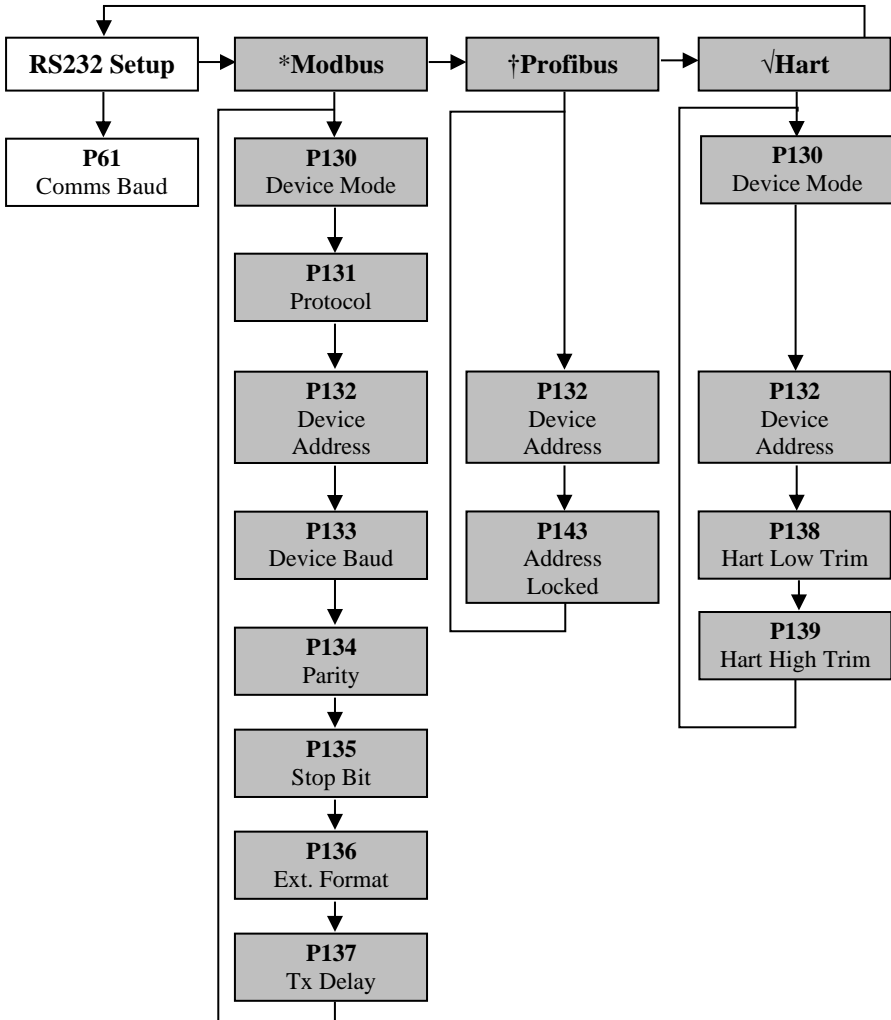

*Options only available on Modbus enabled devices.

† Options only available on Profibus enabled devices.

√ Options only available on HART enabled devices.

Please consult your local Pulsar distributor for more information on different models available.

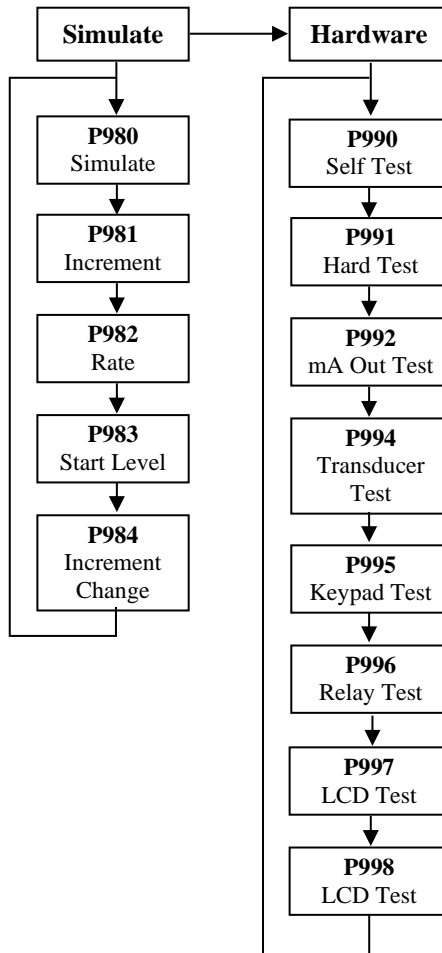
Test Menu

Application Parameters

Operation

P100 Mode of Operation

This parameter sets the mode of operation, when in run mode, and can be set to one of the following:

OPTION	DESCRIPTION
When Ultra Wizard = 1 Level/Volume, 2 Pump or 3 Flow	
1 = Distance (Default)	Display shows the distance from the transducer face to the surface of the material measured.
2 = Level	Shows how full a vessel is.
3 = Space	Shows how empty a vessel is.
When Ultra Wizard = Volume	
5 = Volume	Display shows volume of the vessel.
When Ultra Wizard = Flow	
4 = OCM Head	Display shows how high the head is.
5 = OCM Flow	Display shows the instantaneous flow.

P101 Xducer (Transducer)

This parameter should be set to the transducer being used with the unit, and can be set to one of the following:

OPTION	DESCRIPTION
When Ultra Wizard = 1 Level/Volume, 2 Pump	
0 = None	No transducer is selected
1 = dB3	Transducer is a dB3. Range 0.125 to 3m (0.41 to 9.84 ft)
2 = dB6 (default)	Transducer is a dB6. Range 0.3 to 6m (0.98 to 19.68 ft)
3 = dB10	Transducer is a dB10. Range 0.3 to 10m (0.98 to 32.80 ft)
4 = dB15	Transducer is a dB15. Range 0.5 to 15m (1.64 to 49.21 ft)
7 = dBS6	Transducer is a dBS6. Range 0.2 to 6m (0.65 to 7.95 ft)
8 = dBMach3	Transducer is a dBMach3. Range 0 to 2.425m (0 to 7.96 ft)
When Ultra Wizard = Flow	
1 = dB3	Transducer is a dB3. Range 0.125 to 3m (0.41 to 9.84 ft)
2 = dB6	Transducer is a dB6. Range 0.3 to 6m (0.98 to 19.68 ft)
3 = dB10	Transducer is a dB10. Range 0.3 to 10m (0.98 to 32.80 ft)
4 = dB15	Transducer is a dB15. Range 0.5 to 15m (1.64 to 49.21 ft)
7 = dBS6	Transducer is a dBS6. Range 0.2 to 6m (0.65 to 7.95 ft)
8 = dBMach3 (default)	Transducer is a dBMach3. Range 0 to 2.425m (0 to 7.6 ft)

OPTION	DESCRIPTION
When Ultra Wizard = Level/Volume	
5 = dB25	Transducer is a dB25. Range 0.6 to 25m (1.96 to 82.02 ft)
2 = dB6	Transducer is a dB40. Range 1.2 to 40m (3.93 to 131.23 ft)
Available for all Ultra Wizard options	
*9 = dBR16	Transducer is a dBR16. Range 0.077 to 16m (0.25 to 52.49ft)
*10 = dBR8	Transducer is a dBR8. Range 0.077 to 8m (0.25 to 26.25 ft)

*The signal emanates from the curved face of the radar, but for the purposes of measurement it is taken from the drip shield.

P102 Material

This parameter should be set to the type of material being monitored.

OPTION	DESCRIPTION
1 = Liquid (Default)	Used for liquids and flat solid materials.
2 = Solid	Used for sold material that is heaped or at an angle.
3 = Closed Tank	Use for applications within a closed tank or where a secondary echo response may become focused to create a larger echo than the first.

Dimensions

P104 Measurement Units

This parameter sets the units you want to use for programming and display.

OPTION	DESCRIPTION
1 = metres (Default)	All units of measurement are Metres
2 = cm	All units of measurement are Centimetres
3 = mm	All units of measurement are Millimetres
4 = feet	All units of measurement are Feet
5 = inches	All units of measurement are Inches

P105 Empty Level

This parameter is to be set to the **maximum distance** from the **face** of the transducer to the **empty point**, in **P104 Measurement Units**. Note this value affects span as well, (see the following important information notices), so should be set before span.

Important Notice

When using the dB Mach 3 the empty distance is measured from the end of the horn to the empty point in P104 Measurement Units.

Important Notice

When changing the Empty Distance (P105) you can also recalculate the values for the Span so that it equals the empty distance (P105) minus Near Blanking (P107) and the Relay Setpoints, so that they remain at the same percentage values of the empty distance as they were before you changed the empty distance (P105). You will be asked the question "Recalculate Span?" if you choose yes (enter 1), then the span will be recalculated. Any other answer will leave the span at its original value. You will then be asked if you want to "Recalculate Setpoints?", if you choose yes (enter 1), then all Relay Setpoints will be recalculated as a percentage of the new empty distance. Any other answer will leave the setpoints at their original values.

P106 Span

This parameter should be set to the maximum distance from the **Empty Level (P105)** to the maximum material level. It is automatically set to be equal to the **Empty Level (P105)** less the **Near Blanking** distance (**P107**) when you set the empty level.

P107 Near Blanking

This parameter is the distance from the face of the transducer that is not measurable and is pre-set to the minimum value dependant on the **Transducer (P101)** selected. It should not be set to less than this figure, but can be increased, typically to ignore close in obstructions.

TRANSDUCER	NEAR BLANKING DISTANCE
P101 = dB Mach3	Default Blanking Distance = 0.00m (0 ft)
P101 = dB3	Default Blanking Distance = 0.125m (0.41 ft)
P101 = dB6	Default Blanking Distance = 0.30m (0.98 ft)
P101 = dB10	Default Blanking Distance = 0.30m (0.98 ft)
P101 = dB15	Default Blanking Distance = 0.50m (1.64 ft)
P101 = dB25	Default Blanking Distance = 0.60m (1.96 ft)
P101 = dB40	Default Blanking Distance = 1.20m (3.93 ft)
P101 = dB56	Default Blanking Distance = 0.20m (0.65 ft)
P101 = dB R16	Default Blanking Distance = 0.077m (0.25 ft)
P101 = dB R8	Default Blanking Distance = 0.077m (0.25 ft)

*The signal emanates from the curved face of the radar, but for the purposes of measurement it is taken from the drip shield.

P108 Far Blanking Distance

This is the distance (as a percentage of the **empty level P105**) beyond the empty point that the unit will be able to measure, and by default is pre-set to 20% of the empty level.

If the surface being monitored can be extended beyond the **empty level (P105)** then the far blanking distance can be increased to a max. of 100% of the empty level, provided it does not exceed the max range of the transducer being used. This parameter is always entered as a % of the empty level.

Relay Parameters

All relay related parameters are prefixed with a **2****.

The second digit of the three-figure parameter number denotes the relay number as follows:

- 2**1*** parameters for Relay **1**
- 2**2*** parameters for Relay **2**
- 2**3*** parameters for Relay **3**
- 2**4*** parameters for Relay **4**

The third digit selects specific parameter for the setting of the relays, which can be selected individually and results in the following parameter numbers for each relay:

- Relay 1 2**10** to 2**19**
- Relay 2 2**20** to 2**29**
- Relay 3 2**30** to 2**39**
- Relay 4 2**40** to 2**49**

P2n0 (“n” denotes the relay number in the following parameters)

P2n0 - Relay Type

This parameter defines what type each relay should be, see the table below for available options:

OPTION	DESCRIPTION
0 = Not in use (Default)	Relay is not in use or programmed and the LED will always be off.
1 = Alarm	Relay is programmed as an alarm relay, which will de-energise ON , and energise OFF . This will ensure an alarm is raised if the power fails to the unit.
2 = Pump	Relay is programmed as a pump relay, which will energise ON , and de-energise OFF .
3 = Control	Relay is programmed as a control relay, which will energise ON , and de-energise OFF .
4 = Miscellaneous	Relay is programmed as a miscellaneous relay, which will energise ON , and de-energise OFF .
When Ultra Wizard = 1 Level/Volume	
2 = General Control	Relay is programmed as a general control relay, which will energise ON , and de-energise OFF .

Alarms

P2n0 = 1 (Alarm)

The **second parameter** for each relay determines the **function** of the alarm.

P2n1 – Relay Function

OPTION	DESCRIPTION
0 = Off (Default)	Relay will not operate.
1 = Level	Alarm is based on the level in the vessel, and the type of level alarm (P2n2) and two setpoints must be set (P2n3 & P2n4). Setpoints are entered in Display Units or % of span as referenced to Empty Level*.
2 = Rate of Change	Alarm is based on the rate of change of level in the vessel, and the type of rate of change alarm (P2n2) and two setpoints must be set (P2n3 & P2n4). Setpoints are entered in Display Units per minute or % of span per minute and a negative value should be entered for a Rate Alarm on a decreasing level, and a positive value for an increasing level.
3 = Temperature	Alarm is based on the temperature, and the type of temperature alarm ((P2n2) and two setpoints must be set (P2n3 & P2n4). The temperature used depends on the temperature source selected (P852). Setpoints are entered in °C.
4 = Loss of Echo	Alarm is raised if the Failsafe Timer (P809) expires. No setpoints required.
5 = Loss of Clock	Alarm is raised if the expires. No setpoints required.
6 = Service Alarm	Alarm is raised when the service alarm date/time interval expires. This is set in ' System > Service Alarm > Date (P194) > Interval (P195) '. The alarm trigger is automatic in the unit and is set at 12 noon, meaning that the alarm will activate at 12 noon on the date programmed into the unit when the service is now due. No setpoints are required.
7 = Volume	Alarm is based on the Volume in the vessel and two setpoints must be set (P2n3 & P2n4). Setpoints are entered in Volume units.

OPTION	DESCRIPTION
When Ultra Wizard = 3 Flow	
8 = Flow	Alarm is based on the Flow in the application and two setpoints must be entered (P2n3 & P2n4). Setpoints are entered in Flow units.
9 = Average Flow	Alarm is based on the Average Flow in the application and two setpoints must be entered (P2n3 & P2n4). Setpoints are entered in Flow units.

Important Notice

The Loss of Echo, and Loss of Clock will also be shown on the display as "Lost Echo", and "Lost Clock" respectively.

The **third parameter** for each relay determines the **Alarm ID** for the relay you wish to set.

P2n2 - Relay Alarm ID

When P2n1 = 4 (Loss of Echo) or 5 (Loss of Clock)

This parameter has no function and will not be displayed.

When P2n1 = 1 (Level), 2 = (Rate of Change) or 3 (Temperature)

This parameter defines which **alarm type**, or **identification**, the relay should respond to, as follows:

OPTION	DESCRIPTION	SETPOINTS
1 = General (Default)	Relay goes "ON" when the value reaches the ON setpoint and goes "OFF" when the value reaches the OFF setpoint.	P2n3 is ON Setpoint. P2n4 is OFF Setpoint
2 = High	Relay goes "ON" when the value rises to the ON setpoint and goes "OFF" when the value lowers to the OFF setpoint.	ON > OFF Relay Setpoints P2n3 and P2n4. Setpoints, can be set in any order as the unit 'knows' that you are setting a high-level alarm.
3 = HiHi	Same as 2 = High, but different	identifier
4 = Low	Relay goes "ON" when the value lowers to the ON setpoint and goes "OFF" when the value rises to the OFF setpoint.	ON < OFF Relay Setpoints P2n3 and P2n4. Setpoints, can be set in any order as the unit 'knows' that you are setting a low-level alarm.
5 = LoLo	Same as 4 = Lo, but different	identifier

OPTION	DESCRIPTION	SETPOINTS
6 = In bounds	Relay goes "ON" if value is inside the zone between the two setpoints.	Relay Setpoints, P2n3 and P2n4 can be set in any order as the unit 'knows' that you are setting an inbounds alarm.
7 = Out of bounds	Relay goes "ON" if value is outside the zone between the two setpoints.	Relay Setpoints P2n3 and P2n4 can be set in any order as the unit 'knows' that you are setting an out of bounds alarm.

Important Notice

Setpoints are entered in values according to the function selected.

Level - entered in Measurement Units (P104) or % of span as referenced to Empty Level.

Rate of Change - entered in Display Units per minute or % of span per minute. For an alarm on an increasing level enter setpoints as a positive value, for an alarm on a decreasing level enter setpoints as a negative value.

Temperature - entered in °C.

See the appropriate alarm function, table (P2n1) for further information.



To set figures in % press the  hotkey to show and enter % figure, relative to empty level.

General Control

When Ultra Wizard = 1 Level/Volume

P2n0 = 2 (General Control)

When a relay is being set up as a **control** relay, the **second parameter** that will be displayed in the menu determines its **function**.

OPTIONS	DESCRIPTION
0 = Off (Default)	Relay is always de-energised
1 = On	Control is based on the level in the vessel. All general controls are used to assist each other (run at the same time) and each general control has its own "ON" and "OFF" setpoints.

The **third parameter** has **no function** when **general control** is chosen and will not be displayed.

The **fourth parameter** and **fifth parameter** are set to determine the switch points for the **general control** relay. See the **general control** function, table (P211, 221, 231, P241) for further information.

Important Notice

The General control relays are started and stopped at the "ON" and "OFF" setpoints. To **control down** (reduce level) then set "ON" **higher than** "OFF". To **control up** (increase level) then set "ON" **lower than** "OFF".

Pumps

When Ultra Wizard = 2 Pump or 3 Flow

P2n0 = 2 (Pump)

When a relay is being used for a **pump** function, the **second parameter** determines the **pump duty** that will be used to determine the operating cycle.

P2n1 – Relay Function

This parameter defines which **pump duty** the relay should respond to as follows:

PUMP DUTY	DESCRIPTION
0 = Off (Default)	Relay is always de-energised
1 = Fixed duty assist	All pumps are used to assist each other (run at the same time) and each pump has its own setpoints. (P2n3 & P2n4).
2 = Fixed duty backup	If a pump fails to meet the demand (due to malfunction, intake blockage etc.), then it is stopped, and another pump shall take over. Each pump has its own setpoints. (P2n3 & P2n4).
3 = Alternate duty assist	All pumps are used to assist each other (run at the same time). Each pump has its own setpoints, (P2n3 & P2n4) but each time all pumps have stopped, then the setpoints are sequentially rotated between the pumps to ensure equal pump use.
4 = Alternate duty backup	If a pump fails to meet the demand (due to malfunction, intake blockage etc.), then it is stopped, and another pump shall take over. Each pump has its own setpoints, (P2n3 & P2n4) but each time all pumps have stopped, then the setpoints are sequentially rotated between the pumps to ensure equal pump use.

PUMP DUTY	DESCRIPTION
5 = Duty backup and assist	First pump comes on, if it cannot cope, it goes off and next pump comes on (duty backup). This continues until the last pump comes on and if it cannot cope the first pump comes back on to assist the last pump (duty assist) if the level continues to rise all other pumps will come on (assist) in turn until the level decreases to the pump off points. Each pump has its own setpoints, (P2n3 & P2n4).
6 = Service ratio duty assist	All pumps are used to assist each other (run at the same time) and each pump has its own setpoints (P2n3 & P2n4). And a service ratio setting. The third setpoint (P2n5) is used to set the service ratio. Each time a pump is required to start then the pump with the least running hours (with respect to the service ratio) is started (i.e., the setpoints are re-assigned accordingly). For example, if two pumps A and B have the service ratio set to 2 and 1 respectively, then pump A will operate for twice as many hours as pump B.
7= Service ratio duty backup	If a pump fails to meet the demand (due to malfunction, intake blockage and so on), then it is stopped, and another pump shall take over. Each time a pump is required to start then the pump with the least running hours (with respect to the service ratio) is started (i.e., the setpoints are re-assigned accordingly). Each pump has its own setpoints (P2n3 & P2n4). The third setpoint (P2n5) is used to set the service ratio. For example, if two pumps A and B have the service ratio set to 2 and 1 respectively, then pump A will operate for twice as many hours as pump B.

PUMP DUTY	DESCRIPTION
8 = First On First Off Alternate duty assist	The first pump switched on is the first pump to be switched off, etc. regardless of the set points, so the setpoints are dynamically changed to enable this.
9 = Service Ratio Standby	When a service ratio duty is being used, on all other pumps in use, the standby pump can be started on a ratio basis only, when it will assume the setpoints of the next pump to start. The third setpoint (P2n5) is used to set the service ratio.
10 = Two Pump Sets	There are four pumps. Two rotate their start-up sequence with each other. If the two pumps cannot keep up, the level rise to the setpoints of the other two pumps which take over and rotate their sequence with each other.

The **third parameter** for each relay determines the pump group. You can have two groups of pumps, and all similar duties within that group will operate together.

P2n2 – Relay Pump Group

By **default**, all pump groups are set to **1**, but if you want to have another group, then set this parameter to 2, for each pump relay that should operate together as part of a second group.

The **fourth parameter** and the **fifth parameter** for each relay set the **pump “ON”** and **“OFF”** points, which are entered in **Measurement units P104**. For **pump down** the **“ON”** is set **higher than “OFF”**. For **pump up** then **“ON”** is set **lower than “OFF”**. See the appropriate **pump duty**, function table (**P212, 222, 232**) for further information.

P2n3 – Relay Setpoint 1

This parameter determines the **‘ON’** point of the pump.

Important Notice

The pumps are started and stopped at the **“ON”** and **“OFF”** setpoints. To **pump down** (reduce level) then set **“ON”** higher than **“OFF”**. To **pump up** (increase level) then set **“ON”** lower than **“OFF”**.

P2n4 – Relay Setpoint 2

This parameter determines the '**OFF**' point of the pump.

The **sixth parameter** will determine the **service ratio** that will be used to switch the pump, when **pump duty** selected is a Service Ratio duty.

P2n0 = 6, 7 or 9 (Service ratio)

P21n5 – Relay Setpoint 3

This parameter determines the Service Ratio in values of %. See the appropriate **pump duty** function, table (**P2n1**), for further information.

P2n9 – Relay Max Rate

This parameter will allow a **pump** to be **switched** at a pre-determined **Rate of change of Level**, irrespective of the "ON" level setpoint P2n3. Once a pump relay has been switched "ON" by the pre-determined **Rate of Change**, it will remain energised until the level reaches the "OFF" level setpoint **P2n4**. Max. Rate is entered in Measurement Units (P104) per minute and can be entered as either positive (increasing level) or negative (decreasing level) values.

Control

P2n0 = 3 (Control)

When a relay is being set as a **control** relay, the second parameter that will be displayed in the menu determines its **function**.

P2n1 - Relay Function

This function allows the relay to be assigned to specific **control** functions and mainly work in relation to time.

OPTIONS	DESCRIPTION
0 = Off (Default)	Relay is always de-energised
1 = Time	Relay will energise "ON" after the Cycle time that is set in Relay Setpoint 2 (P2n4) . And turns " OFF ", de-energises , after the On-Time Period that is set in Relay Setpoint 1 (P2n3)

The **third parameter** for each relay determines the **assignment** or **condition** of the relay, where required.

P212, P222, P232 - Relay Alarm ID/Pump Group,

P2n1 = 1 (Time)

This parameter has no function and will not be displayed.

P2n1 = 2 (Step Time)

If the relay is selected for Step Time, then this parameter is used to assign the relay to the 0 = **Open** condition (increase level) or 1 = **Close** condition (decrease level).

The **fourth parameter**, **fifth parameter** and **sixth parameter** are set to determine the switch points, "**ON**" and "**OFF**" for the relay and where required the order of start. See **control function**, table (**P2n1**) for further information.

P2n1 = 1 (Time)

P2n3 - Relay Setpoint 1

This parameter determines the "**Time Period**" that the relay will remain "**ON**". Relay Setpoints are entered in Minutes.

P2n4 - Relay Setpoint 2

This parameter determines the "**Cycle Time**" for the operation of the relay. Relay Setpoints are entered in Minutes.

See the appropriate relay function tables (**P2n1**) for further information.

P2n1 = 2 (Step Time)

P2n3 - Relay Setpoint 1

This parameter will determine the "level" at which the relay will become active. Relay Setpoint 1 is entered in values of Measurement Units (P104)

P2n4 - Relay Setpoint 2

Relay Setpoints are entered in Seconds to set Drive Period, the time that the relay will remain ON.

P2n5 - Relay Setpoint 3

This parameter is used to determine the **Limit Time** between each Drive Period. Relay Setpoints are entered in Minutes, during which time the relay will remain OFF.

Miscellaneous

P2n0 = 4 (Miscellaneous)

When a relay is set to be a **miscellaneous relay**, the **second parameter** determines its **function**.

P2n1 – Relay Function

This function allows the relay to work in relation to a clock or a specific event and will be set to activate in relation to Real Time.

OPTIONS	DESCRIPTION
0 = Off (Default)	Relay is always de-energised
1 = Clock	Relay will energise ON at a specified time each day as set in Relay Setpoint 1 (P2n3). And turns OFF, de-energises , after the specified-On Time period as set in Relay Setpoint 2 (P2n4)
When Ultra Wizard = 3 Flow 2 = Totaliser	Relay will energise ON momentarily each time the specified flow has passed as set in Relay setpoint 1 (P2n3), this parameter sets the multiplication factor which will be applied to the on-board totaliser (P820) to determine the switch point of the relay. E.g., if the totaliser is set to totalise in cubic metres and the relay is required to provide a closure every 10,000 litres Relay setpoint 1 would be set to 10. Relay setpoint 2 (P2n4) is used to select the time the relay will remain closed in seconds.

Important Notice

When using a Relay to control a device at a specified time of day ensure that the Time P932 is set correctly. And if required, enable Daylight Saving for the appropriate time difference P970 – P979.

The **third parameter** has **no function** when **miscellaneous relay** is chosen and will not be displayed.

The **fourth parameter**, and **fifth parameter**, are set to determine the switch points, "ON" and "OFF" for the relay. See **miscellaneous** function table (P2n1) for further information.

P2n0 = 1 (Clock)

P2n3 – Relay Setpoint 1

Relay Setpoints are entered in Hours & Minutes (HH:MM) to set Time at which relay will energise. Default = **00:00 (HH:MM)**

P2n4 – Relay Setpoint 2

Relay Setpoints are entered in seconds to set the **Time Period** that the relay will remain 'ON'. **Default = 0.00 mins.**

P2n0 = 2 (Totaliser)

P2n3 – Relay Setpoint 1

Relay Setpoints are entered as a factor by which the on-board totaliser (P820) should be multiplied by to provide a relay closure. **Default = 0.00**

P2n4 – Relay Setpoint 2

Relay Setpoints are entered in seconds to set the **Time Period** that the relay will remain 'ON'. **Default = 0.00 secs.**

Common Parameters

P2n7– Relay Closures

The Ultra 4 will record how many times each relay has operated, this parameter displays the number of times the relay has activated since the relay has been in use. It can be reset with any value.

P2n8 – Relay Fail Safe

The Ultra 4 has a general fail-safe parameter **P808**. However, this can be overridden so that each individual relay has its own independent fail-safe mode.

This parameter determines what the relay will do in the event of the **Failsafe Time (P809)** expiring.

OPTION	DESCRIPTION
0 = Default	Relay assumes system default mode set in P808
1 = Hold	Relay remains in its current state
2 = De-energise	Relay will De-energise
3 = Energise	Relay will energise

Data Log parameters

The data log parameters contain the following information:

Data Log Setup

The data logged on to the SD card will depend on the system type currently in use, at an interval rate which is set in **P129 Sample Interval**.

P129 Sample Interval

This parameter sets the logging interval a log is sampled from the unit (in minutes) and stored on to the SD card. **Default = 5 minutes**

Logged data points

A full list of the information logged onto the SD card for the different system types is found below:

When System Type = Pump:

- 0 = None
- 1 = Status
- 2 = Level
- 3 = Distance
- 4 = Space
- 5 = mA Out
- 6 = Strength
- 7 = Confidence
- 8 = Temperature
- 9 = Relay Status

When System Type = Level/Volume

As above plus:

- 10 = Volume

When System Type = Flow

Same as System = pump plus:

- 10 = Flow
- 11 = Average Flow
- 12 = Head
- 13 = Tot D
- 14 = Tot R
- 15 = Tot S

Trace Log Setup

Diagnostic echo traces can be periodically stored to the SD card for future play back and analysis using Pulsar PC Suite software. A trace can be stored at a standard time Interval, and at a faster interval when certain diagnostic values exceed defined setpoints.

P917 Trace Log Enable

Turns the ability to log echo traces on or off.

P918 Normal Interval

This parameter sets the trace logging interval that a log is sampled from the unit (in minutes) and stored on to the SD card. **Default = 5 minutes**

P919 Fault Interval

This parameter sets the trace logging interval when the diagnostic values meet or exceed the setpoints defined in the following parameters P961-P968. **Default = 0.5 minutes**

P961 LOE

Log traces when Loss of Echo (LOE) is detected. **Default = 0 (No)**

P962 Xdr Fault

Log traces when Transducer Fault is detected. **Default = 0 (No)**

P963 Failed Safe

Log traces when Failed Safe condition is detected. **Default = 0 (No)**

P964 Min Signal

Log traces when the signal strength is below this value. **Default = -9999 mV**

P965 Max Noise

Log traces when Avg. noise exceeds this value. **Default = 9999 mV**

P966 Min Temp

Log traces when measured temperature is below this value. **Default = -100°C**

P967 Max Temp

Log traces when measured temperature exceeds this value. **Default = 100°C**

P968 Min Confidence

Log traces when echo confidence is below this value. **Default = 0%**

Temperature

The following parameters give information on temperature conditions seen by the **Temperature source (P852)** in °C. These parameters are read only and cannot be changed, though if P852 is changed they will be reset.

P580 Minimum Temperature

This parameter displays the minimum temperature recorded.

P581 Minimum Temperature Date

This parameter displays the date when the minimum temperature was recorded.

P582 Minimum Temperature Time

This parameter displays the time when the minimum temperature was recorded.

P583 Maximum Temperature

This parameter displays the maximum temperature recorded.

P584 Maximum Temperature Date

This parameter displays the date when the maximum temperature was recorded.

P585 Maximum Temperature Time

This parameter displays the time when the maximum temperature was recorded.

P586 Current Temperature

This parameter displays the current temperature.

Totaliser Audits

When Ultra Wizard = 3 Flow

P460 to P479 Total Audits

Parameters **P460-P479** show the **date** and **flow** total for the last **ten days**, the first on the list are the most recent and last ones are the oldest. When all ten total audits are full the oldest is pushed out and all totals increment through to allow the new days total to be registered in the first day's total audit parameter allocation.

Important Notice

To ensure the accuracy of Flow during a 24-hour period, ensure that the **Time P932** is set correctly. And if required, enable **Daylight Saving** for the appropriate time difference **P970 – P979**.

P480 Clear Logs

This parameter enables **all** the Total Audits (P460 – P479) to be cleared to factory default values.

Volume

When Ultra Wizard = 1 Level/Volume

Your Ultra 4 provides a variety of volume calculation features, **with 11** pre-programmed **vessel shapes**. See **Vessel Shape (P600)** for more information. For each vessel, you will need to know the **dimensions (P601-603)** in **Measurement Units (P104)** which are required to calculate the **volume (P604)** which will be displayed in the selected **Volume Units (P605)**.



If your vessel shape does not correspond with any of the pre-programmed vessel shapes, then you can use the **universal calculations**. For this you will need a level/volume graph or chart provided by the vessel manufacturer or you can create one based on the dimensions of the vessel. You can enter up to 32 pairs of breakpoints, and the more you enter, the greater accuracy of the volume calculation will be.

Conversion



P600 Vessel Shape

This parameter determines which vessel shape is used when utilising "Volume Conversion".

The choices are as shown in the table below, along with the **dimensions** that are required to be entered (**P601-P603**).

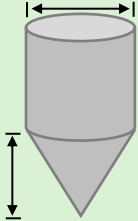
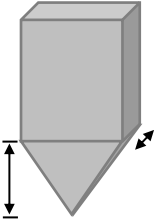
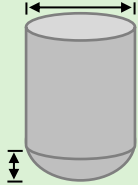
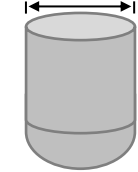
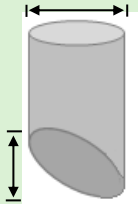
VESSEL SHAPE	P600 VALUE DESCRIPTION	DIMENSIONS
	P600 = 0 (Default) Cylindrical Flat Base	Cylinder diameter
	P600 = 1 Rectangular Flat Base	Width and Breadth

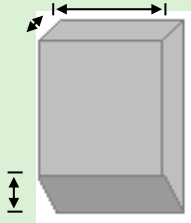
VESSEL SHAPE	P600 VALUE DESCRIPTION	DIMENSIONS
	<p>P600 = 2 Cylindrical Cone Base</p>	<p>Cylinder diameter and height of bottom</p>
	<p>P600 = 3 Rectangular Flat Base</p>	<p>Width and Breadth</p>
	<p>P600 = 4 Parabola Base</p>	<p>Cylinder diameter and height of bottom</p>
	<p>P600 = 5 Flat Sloped Base</p>	<p>Cylinder diameter</p>
	<p>P600 = 6 Flat Sloped Base</p>	<p>Cylinder diameter and height of bottom</p>

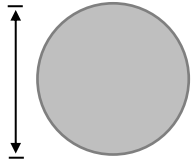
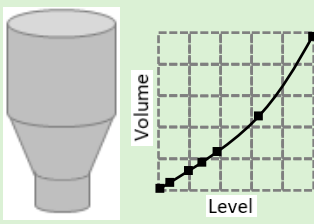
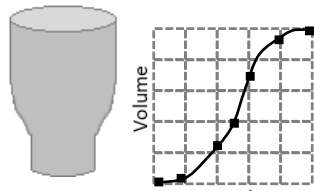
VESSEL SHAPE	P600 VALUE DESCRIPTION	DIMENSIONS
	<p>P600 = 7 Rectangular flat sloped base</p>	<p>Width and breadth of rectangular section and height of bottom</p>
	<p>P600 = 8 Horizontal cylinder with flat ends</p>	<p>Cylinder diameter and tank length</p>
	<p>P600 = 9 Horizontal cylinder with parabolic ends</p>	<p>Cylinder diameter, length of one end and section, and tank length</p>
	<p>P600 = 10 Sphere</p>	<p>Sphere diameter</p>
	<p>P600 = 11 Universal linear</p>	<p>No dimensions required as level, and volume breakpoints are used</p>
	<p>P600 = 12 Universal curved</p>	<p>No dimensions required as level, and volume breakpoints are used</p>

P601-P603 Vessel Dimensions

These three parameters are used to enter the dimension required to calculate the volume. The dimensions required are as shown below and are entered **Measurements Units (P104)**.

VESSEL SHAPE	P601	P602	P603
P600 = 0 Cylindrical flat base	Cylinder Diameter	Not required	Not required
P600 = 1 Rectangular flat base	Not required	Width of rectangle	Breadth of rectangle
P600 = 2 Cylindrical cone base	Height of base	Width of rectangle	Not required
P600 = 3 Rectangular pyramid base	Height of base	Width of rectangle	Breadth of rectangle
P600 = 4 Cylindrical parabola base	Height of base	Cylinder diameter	Not required
P600 = 5 Cylindrical half sphere base	Cylinder diameter	Not required	Not required
P600 = 6 Cylindrical flat sloped base	Height of base	Cylinder diameter	Not required
P600 = 7 Rectangular flat sloped base	Height of base	Width of rectangle	Breadth of rectangle
P600 = 8 Horizontal cylinder flat ends	Length of cylinder	Cylinder diameter	Not required
P600 = 9 Horizontal cylinder parabolic ends	Length of cylinder	Cylinder diameter	Length of one end
P600 = 10 Sphere	Sphere diameter	Not required	Not required

P604 Calculated Volume

This parameter displays the maximum volume that has been calculated by the Ultra 4 and is a Read Only parameter. The volume displayed will be shown in cubic meters and is the total volume available between **empty level (P105)** and 100% of **span (P106)**.

P605 Volume Units

This parameter determines the units that you wish to display, for volume conversion. It is used in conjunction with **P607 (maximum volume)**, and the units are shown on the display (subject to P810). The choices are:

OPTION	DESCRIPTION
0 = No units	Volume will be totalised with no units
1 = Tons	Volume will be totalised in Tons
2 = Tonnes	Volume will be totalised in Tonnes
3 = Cubic metres (Default)	Volume will be totalised in Cubic metres
4 = Litres	Volume will be totalised in Litres
5 = UK Gallons	Volume will be totalised in UK Gallons
6 = US Gallons	Volume will be totalised in US Gallons
7 = Cubic Feet	Volume will be totalised in Cubic Feet
8 = Barrels	Volume will be totalised in Barrels
9 = lbs (pounds)	Volume will be totalised in lbs (pounds)

P606 Correction Factor

This parameter is used to enter a correction factor, when required, such as the specific gravity of the material so that the volume calculated is relative to the actual amount of material that can be contained between **empty level (P105)** and 100% of **span (P106)**. **Default = 1**

P607 Max Volume

This parameter displays the actual maximum volume that has been calculated by the Ultra 4, i.e. **P604 Calculated Volume x P606 Correction Factor**, and is a Read Only parameter. The volume displayed will be shown in **P605 Volume Units** and is the total volume available between **empty level (P105)** and 100% of **span (P106)**.

Breakpoints

P610-P673 Level/Volume Breakpoints

These parameters are used to create a profile of the vessel when **P600=11 (universal linear)** or **P600=12 (universal curved)**. You should enter breakpoints in pairs, a reading for level and its corresponding volume. The more pairs you enter, the more accurate the profile will be. In the case of universal linear, then enter the level/volume at each of the points where the vessel changes shape. In the case of the universal curved, enter values around each arc tangent, as well as at the top and bottom.

You must enter at least two pairs, and you can enter up to 32 pairs.

Universal Linear (P600=11)

This volume calculation creates a linear approximation of the level/volume relationship and works best if the vessel has sharp angles between each section.

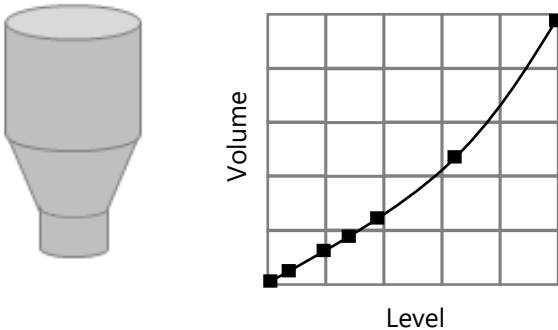

You should enter a level/volume breakpoint for each place where the vessel changes direction, and numerous where the section is slightly curved (mostly linear but has got a small arc). You can enter any number of pairs between 2 and 32.

Universal Curved (P600=12)

This volume calculation creates a curved approximation of the level/volume relationship, and works best if the vessel is non-linear, and there are no sharp angles.

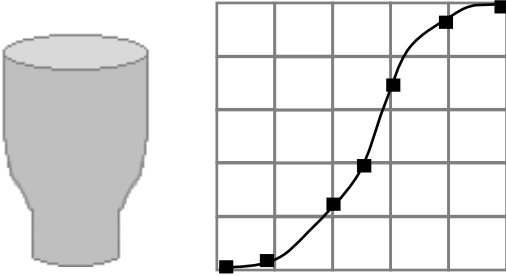

You should enter 2 level/volume breakpoints at the minimum and maximum levels, and several for each place where the vessel has got an arc. You can enter any number of pairs between 2 and 32.

Tables

P696 Reset Breakpoints

This parameter allows the resetting, to the default value, of all previously set breakpoints (P610-673), without having to access them individually. When it is necessary to reset or amend breakpoints this can be achieved by directly accessing the desired parameter (P610-673) and changing as required.

P697 Number of Breakpoints Set

This parameter allows you to review the number of breakpoints that have been set, without the need to access each individual one in turn, this is a "Read Only" parameter and no values can be entered.

OCM Parameters

When Ultra Wizard = 3 Flow

PMD Setup

P700 Primary Measuring Device Type

This parameter is used to select the **type of Primary Measuring Device** and enable additional parameters required to calculate the flow of the Primary Measuring Device chosen (P701). Options are as follows:

0 = Off (Default)

- 1 = Exponent
- 2 = BS3680 Flume
- 3 = BS3680 Weir
- 4 = Not Available
- 5 = Special
- 6 = Universal

P701 Primary Measuring Device

Enter the Primary Measuring Device used.

If P700 = 1 (Exponent)

Select from the following options:

- 1 = Suppressed Rectangular Weir
- 2 = Cipolletti (Trapezoidal) Weir
- 3 = Venturi Flume
- 4 = Parshall Flume
- 5 = Leopold Lagco Flume
- 6 = V- notch Weir
- 7 = Others
- 8 = Rectangular Weir with End Contractions

If P700 = 2 (BS 3680 Flume)

Select from the following options:

- 1 = Rectangular
- 2 = Rectangular with hump
- 3 = U-throated
- 4 = U-Throated with hump

If P700 = 3 (BS 3680 Weir)

Select from the following options:

- 1 = Rectangular
- 2 = V-Notch 90-degree (full 90°)
- 3 = V-Notch 53 degree 8' (half 90°)
- 4 = V-Notch 28 degree 4' (quarter 90°)
- 5 = Broad crested (Rectangular) Weir

If P700 = 5 (Special)

Select from the following options:

- 1 = Palmer-Bowlus Flume
- 2 = H-Flume
- 3 = V-Notch angle (other than BS3680)

If P700 = 6 (Universal)

Where the Primary Measuring device does not match any of the devices contained in the above categories then a universal volume calculation can be performed. A head Vs flow chart is used, to enter several **Breakpoints** for head and flowrate (**P730-793**), which is either provided by the manufacturer or created based on the dimensions of the device.

Select from the following options:

- 1 = Universal Linear flow calculation
- 2 = Universal Curved flow calculation

P702 Calculation

Select the required **calculation method**, both will give similar answers, the difference being the information required to complete the calculation. For ratiometric it is normally sufficient to know the maximum flow at the maximum head. Choose between:

1 = Absolute

2 = Ratiometric (Default)

P703 Minimum Head

This parameter is used to enter the **distance**, above empty, that represents **zero head** and **flow**. This feature is used in Primary Measuring Devices where the zero reference is at a higher level than the channel bottom, at the point of measure. Enter distance in **Measurement Units P104**.

P704 Maximum Head

Enter the **head** value that represents **maximum flow**, enter in **Measurement Units P104**.

Note any change to the value of this parameter will be reflected in P106 (Span) and vice versa.

P705 Maximum Flow

When **P702 = 2 Ratiometric** enter the **flow rate** value that occurs at **maximum head (P704)**, enter in **volume units (P706)** per **time units (P707)**.

When **P702 = 1 Absolute**, and all relevant flow parameters have been entered, the **maximum flow** that occurs **at maximum head P704** will be calculated, after the unit is returned to RUN mode, and displayed in this parameter in **volume units (P706)** per **time units (P707)**.

P706 Volume Units

Select the Volume Units to be used to display and calculate the flow rate from the options below:

OPTION	DESCRIPTION
1 = Litres (Default)	Flow units will be calculated and displayed in Litres
2 = Cubic metres	Flow units will be calculated and displayed in m³
3 = Cubic feet	Flow units will be calculated and displayed in Ft³
4 = UK Gallons	Flow units will be calculated and displayed in UK Galls
5 = US Gallons	Flow units will be calculated and displayed in US Galls
6 = Mil. USG	Flow units will be calculated and displayed in Millions US Galls

P707 Time Units

Select the Time Units to be used with the Volume Units to determine the desired flow rate from the options below:

OPTION	DESCRIPTION
1 = per Second (Default)	Flowrate will be calculated in and displayed in volume units/second
2 = per Minute	Flowrate will be calculated in and displayed in volume units/minute
3 = per Hour	Flowrate will be calculated in and displayed in volume units/hour
4 = per Day	Flowrate will be calculated in and displayed in volume units/day

P708 Flow Decimal

This parameter determines the number of decimal places in the flow rate reading during run mode. It can be set between 1 and 3. **Default = 2**

P709 Flow Cut Off

This parameter is used to select the minimum flow, in a % of flow rate, which is to be totalised. Enter values in % of maximum flow. **Default = 5%**

Dimensions

P710 Dimension A

This parameter is used to enter dimension "A" of the Primary Measuring Device, where applicable, **see table below for further details.**

P711 Dimension B

This parameter is used to enter to enter dimension "B" of the Primary Measuring Device, where applicable, **see table below for further details.**

P712 Dimension C

This parameter is used to enter to enter dimension "C" of the Primary Measuring Device, where applicable, **see table below for further details.**

P713 Dimension D

This parameter is used to enter to enter dimension "D" of the Primary Measuring Device, where applicable, **see table below for further details.**

Dimensions table

PRIMARY MEASURING DEVICE	P710 Dim 'A'	P711 Dim 'B'	P712 Dim 'C'	P713 DIM 'B'
P700 = 1 Exponent P701 = 1 Supp. Rectangular Weir P702 = 1 Absolute	Crest Width	<i>Not Required</i>	<i>Not Required</i>	<i>Not Required</i>
P700 = 1 Exponent P701 = 2 Trapezoidal P702 = 1 Absolute	Crest Width	<i>Not Required</i>	<i>Not Required</i>	<i>Not Required</i>
P700 = 1 Exponent P701 = 5 Leopold Lagco Flume P702 = 1 Absolute	Throat Diameter	<i>Not Required</i>	<i>Not Required</i>	<i>Not Required</i>
P700 = 1 Exponent P701 = 6 V Notch P702 = 1 Absolute	V-Notch Angle	<i>Not Required</i>	<i>Not Required</i>	<i>Not Required</i>
P700 = 2 BS 3680 Flume P701 = 1 Rectangular P702 = Absolute or Ratiometric	Approach Width	Throat Width	Throat Length	<i>Not Required</i>
P700 = 2 BS 3680 Flume P701 = 2 Rectangular with hump P702 = Absolute or Ratiometric	Approach Width	Throat Width	Throat Length	Hump Height
P700 = 2 BS 3680 Flume P701 = 3 U-Throated	Approach Width	Throat Width	Throat Length	<i>Not Required</i>
P700 = 2 BS 3680 Flume P701 = 3 U-Throated with hump P702 = Absolute or Ratiometric	Approach Width	Throat Width	Throat Length	Hump Height
P700 = 3 BS 3680 Weir P701 = 1 Rectangular P702 = Absolute or Ratiometric	Approach Width	Crest Width	Crest Height	<i>Not Required</i>
P700 = 3 BS 3680 Weir P701 = 3 Rect. Broad crested P702 = Absolute or Ratiometric	Approach Width	Crest Width	Crest Height	<i>Not Required</i>
P700 = 5 Special P701 = 1 Palmer Bowlus P702 = Absolute or Ratiometric	Flume Size	<i>Not Required</i>	<i>Not Required</i>	<i>Not Required</i>
P700 = 5 Special P701 = 2 H-Flume P702 = Absolute or Ratiometric	Flume Size	<i>Not Required</i>	<i>Not Required</i>	<i>Not Required</i>
P700 = 5 Special P701 = 3 V-Notch Angle P702 = Absolute or Ratiometric	V – Notch Angle	<i>Not Required</i>	<i>Not Required</i>	<i>Not Required</i>

P714 Roughness Coefficient (Ks)

When P700 = 2, BS3680 Flume this parameter is used to enter the roughness coefficient of the flume in millimetres, **see table below for further details.**

Surface Classification	Value of Ks	
	Good Example mm	Normal Value mm
Plastics etc. Perspex, PVC or other smooth faced Asbestos cement Resin-bonded glass-fibre moulded against smooth forms of sheet metal or well sanded and painted timber	0.03	0.003 0.015 0.06
Metal Smooth, machined, and polished metal Uncoated sheet metal, rust free Painted metal Galvanised metal Painted or coated casting Uncoated casting	0.003 0.015 0.03 0.06 0.06 0.15	0.006 0.03 0.06 0.15 0.15 0.3
Concrete In-situ or precast construction using steel formwork, with all irregularities rubbed down or filled in. In-situ or precast construction using plywood or timber framework Smooth troweled cement rendering Concrete with thin film of sewage slime	0.06 0.3 0.3 0.6	0.15 0.6 0.6 1.5
Wood Planned timber or plywood Well sanded and painted	0.3 0.03	0.6 0.06

P715 Water Temperature

When P700 = 2, BS3680 Flume this parameter is used to enter the mean water temperature in °C.

P717 Exponent

This parameter is used to enter the exponent value when:
 P700 PMD Type = 1 Exponent and P701 Primary M.D = 7 Others.

P718 K Factor

This parameter is used to enter the K Factor when:
 P700 PMD Type = 1 Exponent and P702 Calculation = 1 Absolute, **see table below for further details.**

PRIMARY MEASURING DEVICE	P718 K FACTOR
P700 = 1 Exponent P701 = 1 Supp. Rectangular Weir	Automatically Calculated
P700 = 1 Exponent P701 = 2 Trapezoidal	Automatically Calculated
P700 = 1 Exponent P701 = 3 Venturi Flume	Obtain value and enter
P700 = 1 Exponent P701 = 4 Parshall Flume	Automatically Calculated
P700 = 1 Exponent P701 = 5 Leopold Lagco Flume	Automatically Calculated
P700 = 1 Exponent P701 = 6 V Notch	Automatically Calculated
P700 = 1 Exponent P701 = 7 Other	Obtain value and enter

P719 Throat Width

This parameter is used to select the Throat Width of the flume when: P700 PMD Type = 1 **Exponent** and P701 = 4 **Parshall Flume**. After selecting the Throat Width, the Exponent P717 and K Factor P 718 will be set automatically.

Calculations

The following parameters P720 to P725 are values calculated by the unit, dependent on application, and are "Read Only", therefore have no default values.

P720 Area

Displays the calculated value of the area when, P700 = 2 BS3690 flumes and P700 = 4 Area Velocity.

P721 Cv

Displays the calculated value for Cv when, P700 = 2 BS3680 flumes.

P722 Cd

Displays the calculated value for Cd when, P700 = 2 BS3680 flumes.

P723 Ce

Displays the calculated value for Ce when, P700 = 2 BS3680 weirs.

P724 Cu

Displays the calculated value for Cu when, P700 = 2 BS3680 flume and P701 = 3 or 4 U-Throated flumes.

P725 Kb

Displays the calculated value for Kb when, P700 = 3 BS3680 weirs and P701 = 1 Rectangular weir.

Breakpoints

P730 – P793 Breakpoints

Where the Primary Measuring device does not match any of the pre-programmed devices contained in the Ultra 4, then a universal volume calculation can be performed. A head Vs flow chart is used, to enter several **Breakpoints** for the **head** and **flow (P730-793)**, which is either provided by the manufacturer or created based on the dimensions of the device.

Breakpoints should be entered in **pairs** of **head** and the corresponding **flow** for that head. The **first pair** entered must be for **zero head** and **flow** and the **last pair** entered must be for **maximum head** and **flow**. The higher number of breakpoints (pairs) entered then the greater accuracy there will be. There are a maximum number of 32 breakpoints (pairs) for head and flow that can be entered.

Tables

P796 Reset Breakpoints

This parameter allows the resetting, to the default value, of all previously set breakpoints (P730-793), without having to access them individually. When it is necessary to reset or amend breakpoints this can be achieved by directly accessing the desired parameter (P730-793) and changing as required.

P797 Number of Breakpoints Set

This parameter allows you to review the number of breakpoints that have been set, without the need to access each individual one in turn, this is a "Read Only" parameter and no values can be entered.

Average Flow

P863 Average Flow

This parameter will display the Average Flow for the time period set in **Average Time (P864)**. It is read only and cannot be changed.

P864 Average Time

This parameter will set the time period over which the Average Flow (P863) is to be calculated before being displayed.

Display Parameters

Options

P800 Display Units

This parameter determines whether the reading displayed is in **Measurement Units (P104)**, or as a **percentage of span**.

OPTION	DESCRIPTION
1 = Measured (Default)	Display is in selected unit's dependent in Mode (P100)
2 = Percentage	Display is in percentage of span dependent in Mode (P100)

P801 Decimal Places

This parameter determines the number of decimal places on the reading during run mode. Minimum = 0 (No decimal places), Maximum 3 = (3 decimal Places). **Default = 2** (2 decimal Places).

P802 Display Offset

The value of this parameter is added to the reading before it is displayed, in **Measurement Units (P104)**.

It does not affect the relay setpoints or the mA output, only the reading on the display.

You could use this feature if for example you wanted to reference the reading to sea level, where you would enter the distance between **Empty Level (P105)** and sea level. If the empty level point is below sea level, then enter a negative value.

P804 Display Conversion

The reading is multiplied by the value of this parameter before being displayed. The default is 1.0, but if for example you wanted to display the reading in yards, then set the **Measurement Units (P104)** to feet and set **P804** to 3.

Failsafe

P808 Failsafe Mode

By default, if a fail-safe condition occurs, then the display, relays and the mA output are held at their last **known** values until a valid reading is obtained.

If required, then you can change this so that the unit goes to **high** (100% of span), or **low** (empty) as follows:

OPTION	DESCRIPTION
1 = Known (Default)	Remain at its last known value
2 = High	Will fail to the high value (100% span)
3 = Low	Will fail to the low value (empty)

— See Also P218, P228, P238, P248, P258, 268 - Relay Fail-safe and P840 mA Output Fail-safe

Important Notice

In the event of a fail-safe condition occurring, the display, relays and mA Output can be configured to fail to a condition which is independent of each other. To set independent Relay Failsafe see P2n8. And for independent mA Output Failsafe see P840.

P809 Failsafe Time

In the event of a failsafe condition the failsafe timer determines the time before failsafe mode is activated. **Default = 2mins**

If the timer activates, the unit goes into **failsafe**, as determined by **P808 (Display)**, **P2n8 (Relays)** and **P840 (mA Output)**. When this happens, you will see the message "**Failed Safe!**" on the display, along with a message explaining why (lost echo or transducer fault, for example).

When a valid measurement is obtained then the display, relays and mA output will be restored, and the timer is reset.

Auxiliary

The following parameters **P842, P843, P844, P845, P846** determine which information is to be displayed on the auxiliary line(s) of the display in run mode. Options available depend on system type chosen. A full list of options for each system type is shown in the **Auxiliary Line Options** table further in this chapter.

P842 Aux Line 1

Displays information in run mode on Auxiliary line 1.

P843 Aux Line 2

Displays information in run mode on Auxiliary line 2.

P844 Aux Line 3

Displays information in run mode on Auxiliary line 3.

P845 Aux Line 4

Displays information in run mode on Auxiliary line 4.

P846 Aux Line 5



Displays information in run mode on Auxiliary line 5.

Auxiliary Line Options

OPTION	DESCRIPTION
When Ultra Wizard: 1 = Level/Volume, 2 = Pump, 3 = Flow	
1 = None	No information displayed on Auxiliary Line
2 = Status	Displays the current Status of the transducer
3 = Level	Instantaneous Level reading will be displayed
4 = Distance	Instantaneous Distance reading will be displayed
5 = Space	Instantaneous Space reading will be displayed
6 = mA Out	Instantaneous mA Out reading will be displayed
7 = Strength	Instantaneous Echo Strength figure will be displayed
8 = Confidence	Instantaneous Confidence figure will be displayed
9 = Temperature	Instantaneous Temperature reading will be displayed
When Ultra Wizard: 1 =Level/Volume	
10 = Volume	Instantaneous Volume reading will be displayed
When Ultra Wizard: 3 = Flow	
10 = Flow	Instantaneous Flow reading will be displayed
11 = Average Flow	Current Average Flow reading will be displayed
12 = Head	Instantaneous Head reading will be displayed
13 = Tot D	Instantaneous Daily Totaliser will be displayed
14 = Tot R	Instantaneous Resettable Totaliser will be displayed
15 = Tot S	Instantaneous System Totaliser will be displayed

Totaliser

P820 Totaliser

Displays the current value of the non-resettable totaliser. During run mode, this totaliser can be viewed via the   keys. Unlike the resettable totaliser this totaliser cannot be reset whilst in run mode, it can however be reset whilst in program mode by accessing **P820 Totaliser** and entering a value of **zero**.

P821 Totaliser (R)

Displays the current value of the resettable totaliser. This **totaliser** can be allocated to appear, during **run mode**, on the auxiliary display line (**P842**). The resettable totaliser can be reset whilst in run mode by pressing the  hot key, whilst the totalisers are displayed.

P822 Totaliser Decimal Places

This parameter determines the number of decimal places in the totaliser during run mode. It can be set between 1 and 3. **Default = 2**

P823 Totaliser Multiplication Factor

Sets the unit of totalisation as a multiple of the chosen Flow Volume unit (P706).

E.g., if flowrate is being calculated and displayed in ltrs/second and it is desired to increment the totaliser in cubic metres, select 10 = *1000.

When viewing, the totaliser display will state, "l*1000", and the totaliser will be incremented every 1000 litres The Options are:

OPTION	DESCRIPTION
1= 1/1,000,000	Totaliser will increment every 1/1,000,000th units of flow
2= 1/100,000	Totaliser will increment every 1/100,000th units of flow
3= 1/10,000	Totaliser will increment every 1/10,000th units of flow
4= 1/1,000	Totaliser will increment every 1/1,000th units of flow
5= 1/100	Totaliser will increment every 1/100th units of flow
6= 1/10	Totaliser will increment every 1/10th units of flow
7 = *1 (Default)	Totaliser will increment every 1 units of flow
8= 10	Totaliser will increment every 10 units of flow
9= 100	Totaliser will increment every 100 units of flow
10= 1,000	Totaliser will increment every 1000 units of flow
11= 10,000	Totaliser will increment every 10,000 units of flow
12= 100,000	Totaliser will increment every 100,000 units of flow
13= 1,000,000	Totaliser will increment every 1,000,000 units of flow

P824 Totaliser Enable

This parameter determines if the totaliser is enabled or not, the options are as follows:

OPTION	DESCRIPTION
0 = Off	Totaliser will be disabled
1 = On (default)	Totaliser will be enabled

mA Output Parameters

Range

P830 mA Range

This parameter determines the range of the mA output, from the following:

OPTION	DESCRIPTION
0 = Off	mA output disabled
1 = 0 to 20 mA	mA output directly proportional to the mA mode (P831) , so if the reading is 0% the output is 0 mA. If the reading is 100% the output is 20 mA.
2 = 4 to 20 mA (Default)	mA output directly proportional to the mA mode (P831) , so if the reading is 0% the output is 4 mA. If the reading is 100% the output is 20 mA.
3 = 20 to 0 mA	mA output inversely proportional to the mA mode (P831) , so if the reading is 0% the output is 20 mA. If the reading is 100% the output is 0 mA.
4 = 20 to 4 mA	mA output inversely proportional to the mA mode (P831) , so if the reading is 0% the output is 20 mA. If the reading is 100% the output is 4 mA.

Operation

P831 mA Mode

This parameter determines how the mA Output relates to what is measured. By **default**, it operates the same as the display (**P100**), but it can be set to operate as follows:

OPTION	DESCRIPTION
When Ultra Wizard = 1 Level/Volume, 2 Pump or 3 Flow	
0 = Default	mA output relative to Mode P100
1 = Distance	mA output relative to Distance .
2 = Level	mA output relative to Level .
3 = Space	mA output is relative to Space .
When Ultra Wizard = 1 Level/Volume	
5 = Volume	mA output is relative to Volume
When Ultra Wizard = 3 Flow	
4 = OCM Head	mA output is relative to OCM Head
5 = OCM Flow	mA output is relative to OCM Flow
6 = Average Flow	mA output is relative to Average Flow

Setpoint

By **default**, the mA Output will represent the **empty (0 or 4mA** dependent on (**P830**) **mA Range**) and **100%** of the operational **span (20mA)**, but you may wish to have the output represent a section of the operational span.

For example, the application has an operational span of 6 metres (19.68 ft), but **output** is to **represent empty (0 or 4mA** dependent on (**P830**) **mA Range**) to a **level of 5 metres (20mA)**. If so P834 (Low Level) should be set to 0.00 metres and P835 (High Level) should be set to 5 metres (16.4 ft).

Alternatively, the setpoints can be set to **Flow units (P706)** or **Volume units (P606)** depending on the system type and program used. By default, these setpoints are in **Measurement units (P104)**.

P834 mA Low Level

This parameter sets the level, distance, or space, depending on the selected **mA Out Mode (P831)** at which the low mA output will occur (**0 or 4mA** dependant on (**P830**) **mA Range**). **Default = 0.000m**

P835 mA High Level

This parameter sets the level, distance, or space, depending on the selected **mA Out Mode (P831)** at which the high mA output will occur (**20mA**).

Default = 6.00m

mA Limits

P836 mA Low Limit

This parameter sets the lowest level that the mA output will drop to, the default is 0mA, but you can override this if the device you connect to cannot for example accept less than 2mA, yet you want to use the 0-20mA range.

Default = 4.00mA

P837 mA High Limit

This parameter sets the highest level that the mA output will rise to, the default is 20 mA, but you can override this if the device you connect to cannot for example accept more than 18 mA, yet you want to use the 0-20 mA range. **Default = 20.00mA**

mA Trim

Important Notice

To correctly trim the Ultra 4 mA, connect your DMM to the mA out terminals and screw down so the probes of the DMM are secure.

P838 mA Low Trim

When entering this parameter, you will see the following options displayed on the screen:

OPTION	DESCRIPTION
1 = Measured	Type in the value seen on the DMM and press enter again, and you should see 4mA on your DMM. 'Enter if measured mA = 4mA' appears, if the reading is correct press enter to save the change. When looking back at the parameter you will only see the offset value entered.
2 = Offset	If the remote device you are connected to is not calibrated, and not showing the correct low or high value (reading), then you can trim it using the trim parameters. You can either type in the offset directly or use the arrow keys to move the output up and down until you get the expected result (reading) on the remote device that is connected.

Example:

Measured: When looking at P838 and the DMM is reading 4.32mA, you would type a value of 4.32 into the parameter and press enter. The unit will then output a reading of 4mA.

P839 mA 1 High Trim

When entering this parameter, you will see the following options displayed on the screen:

OPTION	DESCRIPTION
1 = Measured	Type in the value seen on the DMM and press enter again, and you should see 20mA on your DMM. 'Enter if measured mA = 20mA' appears, if the reading is correct press enter to save the change. When looking back at the parameter you will only see the offset value entered.
2 = Offset	If the remote device you are connected to is not calibrated, and not showing the correct low or high value (reading), then you can trim it using the trim parameters. You can either type in the offset directly or use the arrow keys to move the output up and down until you get the expected result (reading) on the remote device that is connected.

Example:

Measured: When looking at P839 and the DMM is reading 19.67, you would type a value of 19.67 into the parameter and press enter. The unit will then output a reading of 20mA.

Important Notice

For units with firmware version 1.0.6 and below please follow the below instructions to trim the mA output:

If the remote device you are connected to is not calibrated, and not showing the correct **low** or **high value** (reading), then you can trim it using the trim parameters.

You can either type in the offset directly or use the arrow keys to move the output up and down until you get the expected result (reading) on the remote device that is connected.

mA Failsafe

P840 mA Failsafe Mode

This parameter determines what happens to the mA output in the event of the unit going into fail-safe mode. The **default** is to do the same as the **system fail-safe (P808)**, but this can be overridden to force the mA output to an independent fail-safe mode as follows:

OPTION	DESCRIPTION
0 = Default	mA output will fail as per P808
1 = Hold	mA output will retain its last known value.
2 = Low	mA output will fail to its low condition.
3 = High	mA output will fail to its high condition.

Compensation Parameters

Offset

P851 Measurement Offset

The value of this parameter is added to the measured distance, in **Measurement Units (P104)**, and will affect everything including the reading on the display, the relay setpoints and the mA output.

Temperature

P852 Temperature Source

This parameter determines the source of the temperature measurement. By **default**, it is set to automatic (**P852=1**), which will automatically detect if a temperature sensor is available from the transducer. If for any reason, no temperature input is received, then the **Fixed Temp** value is used, as set by **P854**.

The temperature source can be specifically set as follows:

OPTION	DESCRIPTION
1 = Automatic (Default)	Will automatically select transducer temperature sensor, if available, or fixed temperature (P854) if no temperature sensor found.
2 = Xducer	Always uses temperature reading from transducer.
3 = Fixed	Always uses fixed temperature (P854)

P854 Fixed Temperature

This parameter sets the temperature, in degrees centigrade to be used if **P852 (Temperature Source) =3. Default = 20°C.**

Velocity

P860 Sound Velocity

This parameter allows for the velocity of sound to be changed according to the atmosphere the transducer is operating in. By default, the velocity is set for sound travelling in air at an ambient temperature of 20 degrees centigrade (at 1bar, atmospheric pressure). **Default = 342.72 m/sec.**

Stability Parameters

Damping

Damping is used to damp the display, to enable it to keep up with the process but ignore minor surface fluctuations.

P870 Fill Damping

This parameter determines the **maximum rate** at which the unit will respond to an **increase in level**. It should be set slightly higher than the maximum vessel fill rate. **Default = 10m/min (32.8084 ft/min).**

P871 Empty Damping

This parameter determines the **maximum rate** at which the unit will respond to a **decrease in level**. It should be set slightly higher than the maximum vessel empty rate. **Default = 10m/min (32.8084 ft/min).**

Rate

P874 Rate Update

This parameter determines the way in which the rate is calculated. If set to **continuous (P874=0)**, then the rate is calculated and displayed continuously, i.e. any change seen from shot to shot is calculated and displayed, but if set to use **values P874=1(Default)** then the **values** set in **P875** and **P876** are used to calculate and display the rate.

P875 Rate Time

This parameter is the period (in seconds) over which the material level rate of change is averaged before the **Rate Value (P877)** is updated. If the **Rate Distance (P876)** is exceeded before the **Rate Time (P875)** has expired, then the **Rate Value (P877)** will be updated immediately. **Default = 60sec.**

P876 Rate Distance

This parameter is the rate **Measurement Units (P104)** over which the material level must change before the **Rate Value (P877)** is updated. If the **Rate Time (P875)** expires before the **Rate Distance (P876)** is exceeded, then the **Rate Value (P877)** will be updated immediately. **Default = 0.05m**

P877 Rate Value

This parameter displays the current rate of change of material level, in **Measurement Units (P104)** per minute. It is read only.

P878 Lower Cutoff

This parameter is used to select the minimum Rate to be calculated and can be used to eliminate unwanted updates from effects of ripples/waves on the surface of the material.

Filters

The following three parameters can be used to filter out unwanted changes of level caused by a 'rippled' or agitated surface.

P880 Gate Mode

This parameter determines the operation of the gate that is established around the echo being processed and is used to track the echoes movement and update the level measurement indication on the display. Please consult Pulsar for further information and assistance on changing the value of this parameter, **Default = 0 (Fixed)**.

P881 Fixed Distance

This parameter determines the width of gate to be used in tracking an echo and under normal circumstances will not require changing, but it can be increased in the cases where the surface is moving extremely fast (more than 10m/min) to ensure smooth processing of the changing level.

Default = 0.2m

P882 Process Filter

This parameter determines the response time of the measurement

OPTION	DESCRIPTION
1 = Fast	level will be updated every cycle
2 = Medium	level will be updated every 8 cycles
3 = Slow (Default)	level will be updated every 16 cycles

P884 Peak Percentage

This parameter is used if you choose a solids application, **P102 Material = 2 (Solids)**, where there maybe angles of repose on the material, and can be used to determine where in the returned echo the displayed level is.

Default = 50%

Echo Processing Parameters

Transducer Status

P900 Transducer Status

This parameter shows the current state of the transducer. The value means the following:

OPTION	DESCRIPTION
0= OK	Transducer working correctly.
1= Disabled	Transducer is not being used (mA input is being used instead, so P101=1)
2= Stuck High	Indicates that the power and signal lines on the transducer terminals are crossed over, or the signal line is shorted to earth.
3= Not Found	No transducer is detected.

P901 Echo Confidence

This parameter displays the most recent echo confidence from the transducer. It is useful to help find the best mounting location for the transducer, where you should aim to get the highest figure. It is a percentage of confidence that the echo reporting the level is the correct one.

P902 Echo Strength

This parameter displays the most recent echo strength figure for the transducer, where a higher figure indicates a better returned echo.

P903 Average Noise

This is the mean noise reading for the transducer. It is measured while the transducer is not firing and gives an indication of the average amount of electrical noise present on the cabling.

P904 Peak Noise

This is the peak noise reading for the transducer. It is measured while the transducer is not firing and gives an indication of the maximum amount of electrical noise present on the cabling.

P905 Sensitivity

This parameter determines the sensitivity of the unit. Please consult Pulsar for further information and assistance on changing the value of this parameter.

P906 Side Clearance

This parameter is used to set the distance by which the DATEM trace will "stand-off" from around unwanted echoes such as obstructions. Please consult Pulsar for further information and assistance on changing the value of this parameter.

System Parameters

Passcode

P921 Enable Code

Enables the passcode (**P922**), which means the passcode must be entered to go into program mode. If **disabled** (set to **0**), then no passcode is required, and ENTER is used to enter program mode. **Default = 1 (Enabled)**

P922 Passcode

This is the passcode that must be used to enter program mode. The **default** is **1997**, but this can be changed to another value from 0 to 9999.

Backup

P925 Parameter Backup & Restore

This parameter is used to make a backup of all parameters, for example to ensure a default set is maintained within the unit. If alterations are made to the parameters that do not work as intended, then the backup set can be restored into the unit.

You can make two separate backup copies if you wish, called backup 1 and backup 2, and restore from either. The options are:

OPTION	DESCRIPTION
1= Backup 1	Make backup to area 1 of all parameters
2= Backup 2	Make backup to area 2 of all parameters
3= Restore 1	Restore all parameters from area 1
4= Restore 2	Restore all parameters from area 2

Params ↔ SD***P935 Parameter File***

This parameter is used to save all parameters in the Ultra4 to the external SD card. It can also be used to restore a parameter file onto the unit from the external SD card.

System Information

The following three parameters do not affect how the unit performs, but details, contained in them, may be required, by Pulsar, when making technical enquiries.

P926 Software Revision

This parameter will display the current software revision. It is read only and cannot be changed.

P927 Hardware Revision

This parameter will display the current hardware revision. It is read only and cannot be changed.

P928 Serial Number

This parameter will display the serial number of the unit. It is read only and cannot be changed.

P929 Site Identification

This parameter allows you to give each unit an individual reference number, for identification purposes. You can set any number between 1 and 99999.

P930 Factory Defaults

This parameter resets all parameter values to the original Factory Set values that were installed when the unit was tested before despatch to you.

To reset parameters, enter **1 (Yes)**, and press ENTER, then you will see a message "Entr if sure", you should press ENTER again. If you press any other key at this point, the parameters will not be reset, and you will see a message confirming this.

Once you have done this, proceed to program the unit to the desired application.

Date & Time

The date and time is used, to control specific relay functions and date stamp certain events that are contained in the Data Logs. It is also used in conjunction with the system watchdog that keeps an eye on the times the unit has started.

P931 Date

This parameter displays the **current date**, in the format as set by **P933 (Date Format)** and can be reset if required.

P932 Time

This parameter displays the **current time** and can be reset if required, in the format HH: MM (24-hour format). This is set initially at the factory for UK time.

P933 Date Format

This parameter allows you to alter the format that the date is displayed to your choice of DD: MM: YY, MM: DD: YY or YY: MM: DD. The default is DD: MM: YY.

Watchdog

You can check how many times the unit has been switched on and look at the date and time of the last ten starts. This can be useful if there have been power failures. The Ultra 4 can be backed up from a battery which automatically cuts in during power failure, battery backed up units will continue uninterrupted operation and therefore will not register a loss of mains power.

The following parameters can be accessed by directly entering the parameter number. To do this, enter the **program mode** and then **type** in the appropriate **parameter number**.

P940 Number of Starts

This parameter shows how many times the unit has been powered up.

P941-P960 Start Date & Time

Parameters **P941** and **P942** show the **date** and **time** that the unit was last started. There are **ten start dates & times** recorded, which are parameters **P943-P960**. The first on the list are the most recent, and the last ones are the oldest. These are read only and cannot be changed.

Daylight Saving Time

Important Notice

To ensure the correct operation of Daylight Saving Time P932 Time should be checked, and adjusted if necessary, to ensure that it is set for the current valid time.

P970 DST Enable

When **Enabled** (set to **1**) the internal clock will be automatically adjusted to compensate for the difference between standard time and **Daylight-Saving Time**. **Default = 1 (Yes)**

P971 DST Difference

This parameter sets the time difference between standard time and **Daylight-Saving Time**. The time difference is entered in HH:MM. **Default = 01:00**

P972 DST Start Time

This parameter is used to set the **time** of day at which **Daylight-Saving Time** will **start**, the time is entered in the format HH: MM (24-hour format). **Default = 02:00**

P973 Start Day

Use this parameter to enter the **day** of the week (**P974**) that **Daylight Saving Time** is to **start**.

OPTION	DESCRIPTION
2= Monday	DST will start on a Monday
3= Tuesday	DST will start on a Tuesday
4= Wednesday	DST will start on a Wednesday
5= Thursday	DST will start on a Thursday
6= Friday	DST will start on a Friday
7= Saturday	DST will start on a Saturday
8= Sunday (Default)	DST will start on a Sunday

P974 Start Week

This parameter will determine the **week** of the month (**P975**) in which **Daylight-Saving Time** is to **start**.

OPTION	DESCRIPTION
1= Week 1	DST will start on day (P973) in the first week (P974) of the month (P975) .
2= Week 2	DST will start on day (P973) in the second week (P974) of the month (P975) .
3= Week 3	DST will start on day (P973) in the third week (P974) of the month (P975) .
4= Week 4	DST will start on day (P973) in the fourth week (P974) of the month (P975) .
5= Last (Default)	DST will start on day (P973) in the last week (P974) of the month (P975) .

P975 Start Month

This parameter is used to select the **month**, in which **Daylight-Saving Time** will **start**.

OPTION	DESCRIPTION
1= January	DST will start during the month of January
2= February	DST will start during the month of February
3=March (Default)	DST will start during the month of March
4= April	DST will start during the month of April
5= May	DST will start during the month of May
6= June	DST will start during the month of June
7= July	DST will start during the month of July
8= August	DST will start during the month of August
9= September	DST will start during the month of September
10= October	DST will start during the month of October
11= November	DST will start during the month of November
12= December	DST will start during the month of December

P976 DST End Time

This parameter is used to set the **time** of day at which **Daylight-Saving Time** will **end**, the time is entered in the format HH: MM (24-hour format).
Default = 02:00.

P977 DST End Day

Use this parameter to enter the **day** of the week (**P974**) that **Daylight Saving Time** is to **end**.

OPTION	DESCRIPTION
2= Monday	DST will end on a Monday
3= Tuesday	DST will end on a Tuesday
4= Wednesday	DST will end on a Wednesday
5= Thursday	DST will end on a Thursday
6= Friday	DST will end on a Friday
7= Saturday	DST will end on a Saturday
8 = Sunday (Default)	DST will end on a Sunday

P978 End Week

This parameter will determine the **week** of the month (**P975**) in which **Daylight-Saving Time** is to end.

OPTION	DESCRIPTION
1= Week 1	DST will end on day (P973) in the first week (P974) of the month (P975).
2= Week 2	DST will end on day (P973) in the second week (P974) of the month (P975).
3= Week 3	DST will end on day (P973) in the third week (P974) of the month (P975).
4= Week 4	DST will end on day (P973) in the fourth week (P974) of the month (P975).
5= Last (Default)	DST will end on day (P973) in the last week (P974) of the month (P975).

P979 End Month

This parameter is used to select the **month**, in which **Daylight-Saving Time** will **end**.

OPTION	DESCRIPTION
1= January	DST will end during the month of January
2= February	DST will end during the month of February
3= March	DST will end during the month of March
4= April	DST will end during the month of April
5= May	DST will end during the month of May
6= June	DST will end during the month of June
7= July	DST will end during the month of July
8= August	DST will end during the month of August
9= September	DST will end during the month of September
10= October (Default)	DST will end during the month of October
11= November	DST will end during the month of November
12= December	DST will end during the month of December

Service Alarm

An alarm can be raised if the Ultra 4 or the application is due for a service.

P195 Interval

This parameter allows a repeat interval (in days) to be set to indicate the time between each service. When a service alarm is triggered and reset by using **P199**, the new service alarm will activate by the amount of days set in this parameter. For example, if 365 has been entered, then after a reset is done the new alarm will automatically be set to activate in 365 days' time.

At midnight, every day on the unit the interval will reduce until the service alarm is due. The service alarm relay that is programmed (details of how to do this are shown in **Relays > Alarms** section of this manual), changes state and the square indicator will become solid black.

And when activated a message will appear on the display indicating a service is due, and will display the following message on the Main run mode screen:

Service due. Call 01684 891371

P196 STD Leading zeroes

This parameter is used to enter the number of 0's that appear at the beginning of the phone number that is shown on the screen when the service alarm messages are displayed. For example, enter '00' for an international number, and enter '0' for a mobile or local STD number.

P197 STD Phone STD code

This parameter is used to enter the 'STD' or 'Area code' of the phone number that is shown on the screen when the service alarm messages are displayed. If '00' or '0' has been entered in '**P196**' then you do not need to enter any leading zeroes into this parameter for an STD code or mobile number. Instead enter the first four digits of the number.

P198 Phone number

This parameter is used to enter the digits of the remaining telephone number.

P199 Service alarm reset

After the service is carried out, use this parameter to reset the service alarm. To enable a reset, enter a value of '1' and press 'Enter' and the alarm is now reset. If an Interval (**P195**) is set, then the service alarm will next activate according to the value in **P195**.

P194 Interval remaining

This is a read only parameter and displays how many days are remaining until the service alarm activates.

Language

P934 Language

This parameter selects the language that the unit can be set up to and display all information to the language selected. Options are as follows:

1. **English (Default)**
2. French
3. German
4. Italian
5. Spanish
6. Swedish

Device Comm.

RS232 Set Up

P061 Comms Baud

This parameter is used to set the speed (Baud Rate) of the RS232 communications and can be changed to suit the connecting device. Options are as follows:

1. 2400
2. 4800
3. 9600
4. **19200 (Default)**
5. 38400
6. 57600
7. 115200

Modbus

Terminal connections, colours of cables only used for example purposes:

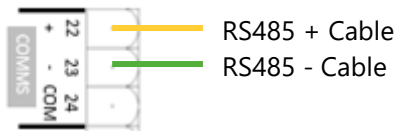

P130 Device Mode

This parameter is used to determine whether the Ultra 4 is a Slave device or not.

OPTION	DESCRIPTION
0 = Off (Default)	Communication is switched OFF
1 = Slave	Ultra 4 is set as a Slave unit

P131 Protocol

This parameter is used to determine what Modbus protocol is being used.

OPTION	DESCRIPTION
0 = Modbus RTU (Default)	Protocol used is Modbus RTU
1 = Modbus ASCII	Protocol used is Modbus ASCII

P132 Device Address

This is the Modbus slave address of the Ultra 4. **Default = 126**

P133 Device Baud Rate

Sets the speed of the RS485 digital communications interface to match that of the device it is communicating with. **Default = 19200**

P134 Parity

Determines the parity of the Ultra 4 to match that of the device it is communicating with, choices are between None, Odd or Even.

P135 Stop Bit

Shows the value of the bits that signal the end of an asynchronous transmission.

P136 External Format

This parameter determines what type of data format is used

OPTION	DESCRIPTION
0 = Unsigned Integer (Default)	16 bit which contains values from 0 – 65335
1 = Signed Integer	16 bit which contains values from -32768 to +32768.
2 = Float Modicon	This is an order in which the most significant value in the sequence is stored first.
3 = Float IEEE	This is an order in which the least significant value in the sequence is stored.

P137 Tx Delay

This parameter is used to set a delay, if required, between the Ultra 4 switching from transit (Tx) mode to receive mode (Rx).

Profibus

Terminal connections, colours of cables only used for example purposes:

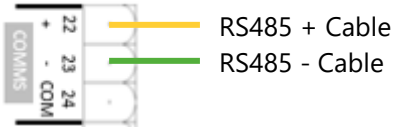

P130 Device Mode

This parameter is used to determine whether the Ultra 4 is a Slave device or not.

OPTION	DESCRIPTION
0 = Off (Default)	Communication is switched OFF
1 = Slave	Ultra 4 is set as a Slave unit

P132 Device Address

This is the Profibus slave address of the Ultra 4. **Default = 126**

P143 Address Locked

This parameter determines whether the unit address is locked and unable to be changed by the Profibus master.

0 = No (Default) and 1 = Yes.

HART

Ultra 4 HART modem supports isolated (i.e. floating) single and multi-drop connections, thereby permitting active or passive modes. Terminal connections, communicating to software such as PACTware are shown as below:

Active Mode 1 (Using Ultra 4 internal supply):

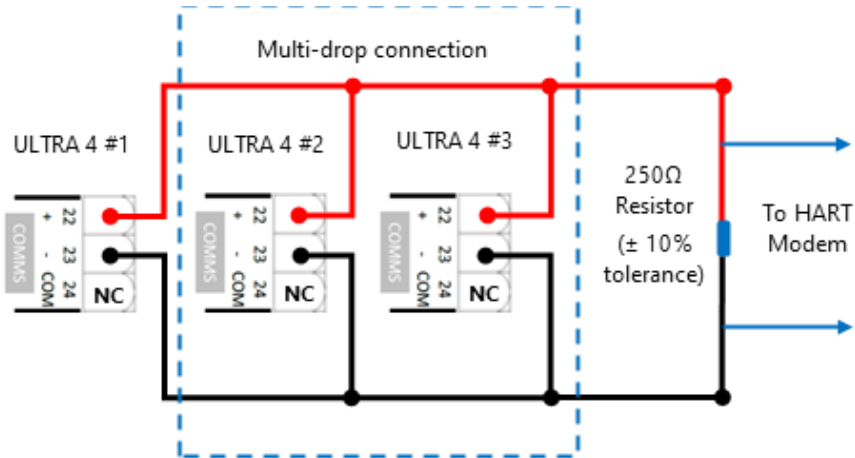

Active Mode 2 (Connected to self-powered device):

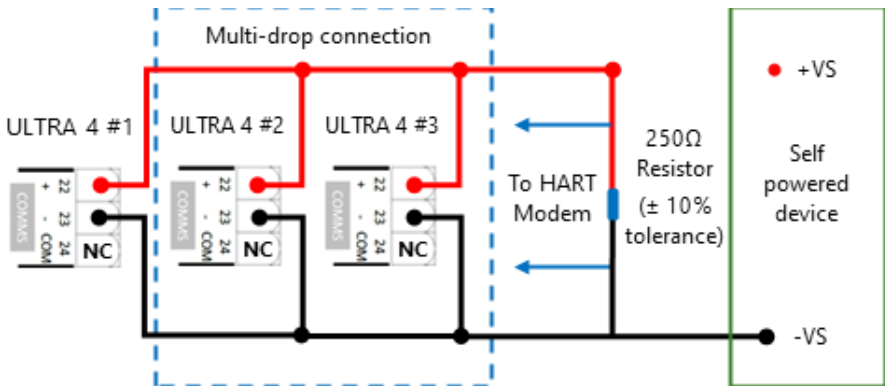

Passive Mode (Using an external PSU):

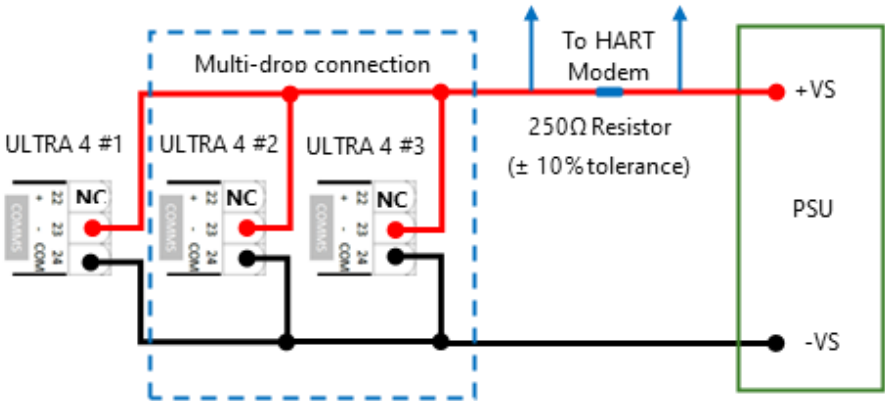

P130 Device Mode

This parameter is used to determine whether the Ultra 4 is a Slave device or not.

OPTION	DESCRIPTION
0 = Off (Default)	Communication is switched OFF
1 = Slave	Ultra 4 is set as a Slave unit

P132 Device Address

This is the HART slave address of the Ultra 4. **Default = 126**

Test Parameters

Simulation

P980 Simulate

Test mode is used to simulate the application and confirm that all parameters and relay setpoints have been entered as expected. During simulation, there is a choice of whether the relays will change state (hard simulation) or not (soft simulation), but the LED's will always change colour as programmed, and the current output will change. If you want to test the logic of the system that the relays are connected to then select a hard simulation, but if you do not want to change the relay state, then select a soft simulation.

There are two simulation modes, **automatic** and **manual**. Automatic simulation will move the level up and down between empty level or the pre-determined **Start Level (P983)** and Pump/Control relay switch points, if you wish to change the direction of the level movement e.g., to go beyond relay setpoints, this can be done by using the arrow keys. In manual simulation, using the arrow keys will allow you to move the level up and down as required.

The choices for you to enter are as follows.

- 1= Manual soft simulation
- 2= Automatic soft simulation
- 3= Manual hard simulation
- 4= Automatic hard simulation

Whilst in Automatic hard simulation (**P980 = 4**) the switching of digital inputs can be simulated by pressing the corresponding numeric key to the input to be switched, each time the numeric key is pressed it will toggle the input between On and Off.

To return to program mode, press 'CANCEL' and test mode will end.

Important Notice

Pump start delay (which by default is 10 seconds) is set to 0 during simulation.

P981 Increment

By **default**, simulation mode will move by **0.1m** steps in manual simulation and by **0.1m/min** in automatic simulation. Altering the increment can change this value.

P982 Rate

In automatic mode, the rate at which the level will move up and down, is determined by distance, **P981 Increment** and the time, **P982 Rate** which by **default** is set to **1min** and can be changed as required. To increase the rate at which the level moves increase the **Increment (P981)** or decrease the **Rate (P982)**. To decrease the rate at which the level moves decrease the **Increment (P981)** or increase the **Rate (P982)**.

P983 Start Level

When using automatic simulation this parameter can be used to pre-determine the point at which the simulated level will start at and return to. This can be used to simulate the lowest point to which the level would normally operate.

P984 Inc. Change

When using automatic simulation, you can incrementally increase or decrease the rate whilst running simulation. The rate is increased /decreased incrementally by the value **P984 (Incremental Change)** by using the "**decimal point**" key to **increase** and the "**plus/minus**" key to **decrease** the rate of change.

Default = 0.1m

Hardware

P990 Self Test

If you enter 1 for this parameter, then the unit will perform a self-test. This will confirm that the various parts of the circuitry are working correctly. You will see confirmation messages that the clock and the EEPROM are working correctly, and error messages for any parts that fail.

P991 Hard Test

When this parameter is selected, the unit will test the following in turn.

- **Relays.** Press a numeric key corresponding to the number of the relay you wish to test, and the relay will change state each time the key is pressed. If you press any other key, other than a valid relay number, then the test will end.
- **Display.** The LCD will steadily be blacked out, so you can see if the screen is working. Press, ENTER, to end the display test and move onto the next test.
- **Keys.** You should press each key, to confirm it works, with a counter showing how many more keys you have to press. Be sure to press the **CANCEL** key last, as this will show if all keys were pressed or not. If they were not, then an error message is displayed.

P992 mA Out Test

This parameter will allow you to force a specified current on the mA output, to test the equipment that it is connected to, and to make sure the unit is working correctly. The figure you enter will be generated by the mA output.

P994 Transducer Test

If you enter 1 for this parameter it will continually fire the transducer, so you can check the wiring, until you press any key to cancel.

P995 Keys Test

You should press each key, to confirm it works, with a counter showing how many more keys you have to press. Press the **CANCEL** key last, as this will confirm if all keys were pressed or not. If they were not, then an error message is displayed.

P996 Relay Test

Press a numeric key corresponding to the number of the relay you wish to test, and the relay will change state each time the key is pressed. If you press any other key, other than a valid relay number, then the test will end.

P997 LCD Test

Turns all LCD segments black for 5 seconds to allow the functionality of the display to be visually checked.

P997 SD Card Test

Conducts a read & write test to the SD card.

CHAPTER 9 SD CARD LOGGER

This section outlines how to setup, use and retrieve information from the SD card on the Ultra 4.

About the Micro SD card logger

The Ultra 4 comes supplied with a micro-SD card capable of storing a vast amount of logged data onto it at regular intervals which can be set in program mode (Data Logs menu). The Ultra 4 detects the card when it is inserted and prepares it for use. An SD card symbol appears alongside the time at the bottom-right of the display, indicating the presence of the card. Before removing the micro-SD card, the [.] button on the keypad should be pressed – the LCD will briefly display a message 'Safe to remove SD Card' and the SD card symbol will flash about once per second. **NOTE:** If the SD card is not removed when the SD indicator is flashing, the card will be remounted after 5 minutes.

Types of Files

There are currently 5 file types that may be found on the SD card, a description of these types is listed as follows:

Trend logs. These are stored in folders with the name format **L***yyymmdd***X**, where **L** indicates that it is a data log-file, *yyymmdd* are 2-digit year, month and day, and **X** is a letter from A to Z that is added in case more than one folder is created on the same date. For example, L190503A would be the first trend file folder created on 5th May 2019.

The files within the folder have filenames of the format **L***hhmmss***X**.CSV, where *hhmmss* represents hours (24hr), minutes and seconds. The file extension .CSV indicates a comma-separated value file that can be opened in a text editor or in spreadsheet applications. The data within the files varies according to the configuration in the **Data Logs** menu, but each record has a time & date stamp. A new trend log folder will be created each day. Once a trend file reaches 1MB in size, a new file will be created within the daily folder.

Event logs. Certain 'events' are recorded to files on the micro-SD card. These events include relay switching, SD card remove/insert, access to program mode, and power up events. Once an event file reaches 1MB in size, a new file will be created. The naming of the files and folders is like those for Trend Logs except that the names are prefixed with E rather than L.

Trace logs. The naming of the files and folders is like those for Data Logs except that the names are prefixed with T rather than L, and the file name extension is .DAT, which allows the traces to be replayed in Ultra PC (within PC suite software). If enabled in the Data Logs menu, a new folder for trace logs will be created each day. Once a trace file reaches 1MB in size, a new file will be created.

Firmware files. The firmware in the Ultra 4 can be upgraded from a file placed on the SD card. Firmware files have the extension .PU4. Contact Pulsar for more information on Upgrading the Firmware.

Parameter files. A file of the current parameter settings can be saved to the SD card and used as a backup, for archives, or to load into another Ultra 4 to "clone" the current parameter configuration.

The file name is prefixed with F, P or V depending on whether the unit is configured as Flow (F) Pump (P) or Level/Volume (V). The rest of the file name follows the same *yymmddX* format as described above. The file name extension is .PR4. These files are also stored in the root folder.

When creating a parameter backup file, the filename is generated automatically. When restoring parameters from a backup file the Ultra4 shows a list of available files to load.

Setting up the unit to log

Ensure that a micro-SD card has been inserted into the SD card slot ready to begin logging. When the programming of the unit has been completed and you return to run mode, the unit will begin to log data at the time interval defined within the **Data Logs** menu.

You can view the micro-SD card logging information on Page 2 of the Info screen in run mode. Page 3 of the Info screen will show you how much memory you have left on the micro-SD card you are using.

Data gets written to the SD card in blocks every 15-minutes, or once the amount of data to write reaches a pre-set limit.

CHAPTER 10 TROUBLESHOOTING

This section describes many common symptoms, with suggestions as to what to do. If the issue persists, please contact your local Pulsar distributor.

SYMPTOM	WHAT TO DO
Display blank, transducer not firing.	Check power supply, voltage selector switch and fuse.
Displays "No Xducer"	Check wiring to transducer.
Displays "Xducer Flt"	There is a fault with the transducer wiring, so check wiring to transducer.
Displays 'Failed Safe'	The transducer has not been able to lock on to a target. Check transducer wiring, check P900 status. Check to see if transducer is 'clicking', check for any obstructions in the application.
Incorrect reading being displayed for current level.	Measure actual distance from transducer head to surface of material. Enter Program Mode and directly access P21 (Set Distance) type in the measured distance, ENTER, ENTER again when prompted, wait until SET displayed and return to Run Mode, display should now update to correct reading.
Material level is consistently incorrect by the same amount.	Check empty level, (P105) display offset, (P802) and measurement offset (P851).
LED's change colour at relevant relay switch points but relays do not change state.	Check supply to unit and ensure voltage selector set to correct position.

If you experience any other issues that are not mentioned in the above troubleshooting guide, please contact your local Pulsar distributor for further assistance.

CHAPTER 11 DISPOSAL

Incorrect disposal can cause adverse effects to the environment.

Dispose of the device components and packaging material in accordance with regional environmental regulations including regulations for electrical \ electronic products.

Transducers

Remove power, disconnect the Transducer, cut off the electrical cable and dispose of cable and Transducer in accordance with regional environmental regulations for electrical \ electronic products.

Controllers

Remove power, disconnect the Controller, and remove battery (if fitted).

Dispose of Controller in accordance with regional environmental regulations for electrical \ electronic products.

Dispose of batteries in accordance with regional environmental regulations for batteries.



 EU WEEE Directive Logo

This symbol indicates the requirements of Directive 2012/19/EU regarding the treatment and disposal of waste from electric and electronic equipment.



www.pulsarmeasurement.com

SUPPORT@PULSARMEASUREMENT.COM

Copyright © 2020 Pulsar Measurement Ltd.

Registered Address: 1 Chamberlain Square CS, Birmingham B3.3AX

Registered No.: 3345604 England & Wales

Rev 1.0